

Nederlands

Schranklader

Skid Steer Loaders

1350R NXT2

MACHINEBOOK



Hoedanigheid		Metrisch
Rated Operating Capacity		612 kg
Rated Operating Capacity with Optional Counterweight		680 kg
Leeg gewicht		2384 kg
Gewicht en afmetingen		
Wielbasis (y)	y	950 mm
Overall Operating Height - Fully Raised	h27	3670 mm
Hoogte tot schamierpen - volledig verhoogd	h28	2794 mm
Overall Height to top of ROPS	h17	1930 mm
Storhoek op volledige hoogte	a5	40 °
Dump height	h29	2123 mm
Overall length with bucket	l16	3076 mm
Dump reach - Full height	r6	584 mm
Terugrollen op de grond	a13	28 °
Seat to ground height	h30	871 mm
Overall width less bucket	b1	1364 mm
Bakbreedte	e1	1372 mm
Bodemvrijheid machine	m4	203 mm
Overall length - Less Bucket	l2	2360 mm
Starthoek	a2	25 °
Clearance Radius - Front with Bucket	b18	1842 mm
Rear departure angle		25 °
Prestatie		
Rijsnelheid (onbelast)		12.90 km/h
Banden		
Modellen banden		10 x 16.5 - 10 PR HD
Motor		
Merk		Yanmar
Motomodel		4TNV88C-KMS
Motomom		Stage V
Gross Power		34.30 kW
Max. koppel / Motorkoppel		146.20 Nm / 2800 rpm
Stroombron		Diesel
I.C. Motorvermogen		46 Hp
Batterij		12 V
Alternator		100 kW
Starter		2.30 kW
Hydraulisch		
Hulphydrauliek		63.60 l/min
Auxiliary Hydraulic Pressure		207 bar
Tankinhoud		
Inhoud brandstoftank		59.40 l
Inhoud hydraulische tank		34.80 l
Cilinderinhoud		2.20 l
Volume van de vloeistofkoeltank		7.90 l
Geluid en trillingen		
Lawaai in de omgeving (LwA)		82 dB
Lawaai op de bestuurdersplaats (LpA)		100 dB
Whole-Body Vibration (ISO 2631-1)		0.81 m/s ²
Trillingen op het geheel handen/armen		< 1.90 m/s ²

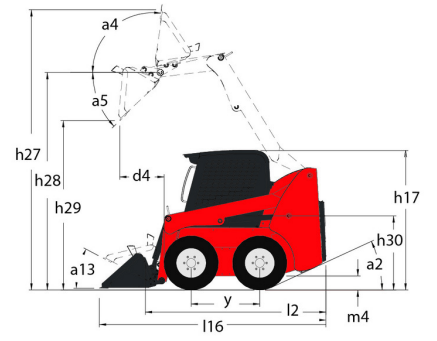
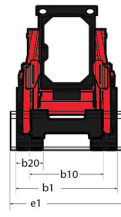
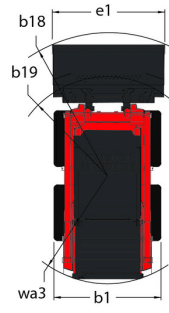

BAKKEN

4-in-1 bak (compacte machines)



4-in-1 bak (compacte machines) - B4x1 1380 / 300

Capaciteit van de koepel	Gewicht	Totale hoogte	Breedte	Diepte	All-Tach®
300 l	250 kg	721 mm	1380 mm	730 mm	N736018

Verplichte uitrusting van machines : 



4-in-1 bak (compacte machines) - B4x1 1520 / 330

Capaciteit van de koepel	Gewicht	Totale hoogte	Breedte	Diepte	All-Tach®
330 l	253 kg	721 mm	1520 mm	730 mm	N736019

Verplichte uitrusting van machines : 



4-in-1 bak (compacte machines) - B4x1 1550 / 340

Capaciteit van de koepel	Gewicht	Totale hoogte	Breedte	Diepte	All-Tach®
340 l	260 kg	721 mm	1550 mm	730 mm	N736067

Verplichte uitrusting van machines : 

BAKKEN

4-in-1 bak met tanden(compacte machines)



4-in-1 bak met tanden(compacte machines) - B4x1 1380 / 300 T

Capaciteit van de koepel	Gewicht	Totale hoogte	Breedte	Diepte	All-Tach®
300 l	250 kg	721 mm	1380 mm	730 mm	N736020

Verplichte uitrusting van machines : 



4-in-1 bak met tanden(compacte machines) - B4x1 1520 / 330 T

Capaciteit van de koepel	Gewicht	Totale hoogte	Breedte	Diepte	All-Tach®
330 l	253 kg	721 mm	1520 mm	730 mm	N736021

Verplichte uitrusting van machines : 



4-in-1 bak met tanden(compacte machines) - B4x1 1550 / 340 T

Capaciteit van de koepel	Gewicht	Totale hoogte	Breedte	Diepte	All-Tach®
340 l	260 kg	721 mm	1550 mm	730 mm	N736068

Verplichte uitrusting van machines : 

BAKKEN

Allroundbak (compacte machines)

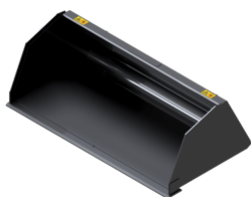

Allroundbak (compacte machines) - BU 1380 / 380

Capaciteit	Capaciteit van de koepel	Gewicht	Totale hoogte	Breedte	Diepte
570 kg	380 l	146 kg	524 mm	1380 mm	889 mm
All-Tach®					
N736011					

Verplichte uitrusting van machines : 

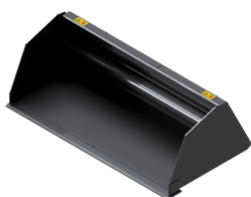

Allroundbak (compacte machines) - BU 1520 / 430

Capaciteit	Capaciteit van de koepel	Totale hoogte	Breedte	Diepte	All-Tach®
645 kg	430 l	524 mm	1520 mm	889 mm	N736012

Verplichte uitrusting van machines : 

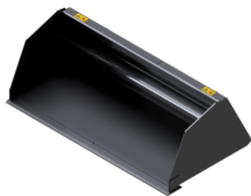

Allroundbak (compact machines) - BU 1680 / 590

Capaciteit	Capaciteit van de koepel	Gewicht	Totale hoogte	Breedte	Diepte
885 kg	590 l	250 kg	572 mm	1680 mm	948 mm
All-Tach®					
N747008					

Verplichte uitrusting van machines : ✕

BAKKEN

Groot volumebak (compact machines)



Groot volumebak (compact machines) - BLM 1220 / 330

Capaciteit	Capaciteit van de koepel	Totale hoogte	Breedte	Diepte	All-Tach®
330 kg	330 l	490 mm	1220 mm	819 mm	N726011

Verplichte uitrusting van machines : ✕



Groot volumebak (compact machines) - BLM 1380 / 430

Capaciteit	Capaciteit van de koepel	Gewicht	Totale hoogte	Breedte	Diepte
430 kg	430 l	140 kg	600 mm	1380 mm	890 mm
All-Tach®					
N736013					

Verplichte uitrusting van machines : ✕



Groot volumebak (compact machines) - BLM 1520 / 480

Capaciteit	Capaciteit van de koepel	Totale hoogte	Breedte	Diepte	All-Tach®
480 kg	480 l	600 mm	1520 mm	890 mm	N736014

Verplichte uitrusting van machines : ✕



Groot volumebak (compacte machines) - BLM 1680 / 530

Capaciteit	Capaciteit van de koepel	Gewicht	Totale hoogte	Breedte	Diepte
530 kg	530 l	160 kg	600 mm	1680 mm	890 mm
All-Tach®					
N736015					

Verplichte uitrusting van machines : ✕

BAKKEN

Industriële klem (compacte machines)



Industriële klem (compacte machines) - BGI 1380 / 210

Capaciteit van de koepel	Gewicht	Breedte	Gesloten grijphoogte	Diepte	All-Tach®
210 l	292 kg	1380 mm	704 mm	958 mm	N736031

Verplichte uitrusting van machines :

BAKKEN

Sloopbak met hoge weerstand (Compacte machines)

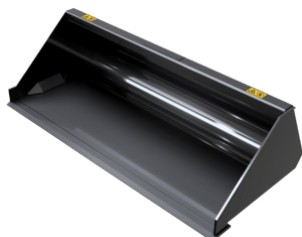

Sloopbak met hoge weerstand (Compacte machines) - BD 1380 / 320

Capaciteit van de koepel	Gewicht	Totale hoogte	Breedte	Diepte	All-Tach®
320 l	137 kg	470 mm	1380 mm	841 mm	N736008

Verplichte uitrusting van machines : ✕

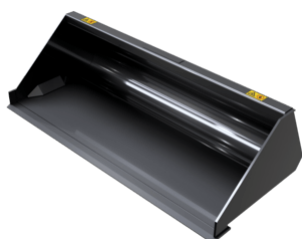

Sloopbak met hoge weerstand (Compacte machines) - BD 1520 / 350

Capaciteit van de koepel	Gewicht	Totale hoogte	Breedte	Diepte	All-Tach®
350 l	143 kg	470 mm	1520 mm	841 mm	N736009

Verplichte uitrusting van machines : ✕

BAKKEN

Standaard graafbak (compacte machines)



Standaard graafbak (compacte machines) - BS 1380 / 320

Capaciteit van de koepel	Gewicht	Totale hoogte	Breedte	Diepte	All-Tach®
320 l	137 kg	470 mm	1380 mm	841 mm	N736002

Verplichte uitrusting van machines : ✕



Standaard graafbak (compacte machines) - BS 1480 / 340

Capaciteit van de koepel	Gewicht	Totale hoogte	Breedte	Diepte	All-Tach®
340 l	141 kg	470 mm	1480 mm	841 mm	N736061

Verplichte uitrusting van machines : ✕



Standaard graafbak (compacte machines) - BS 1520 / 350

Capaciteit van de koepel	Gewicht	Totale hoogte	Breedte	Diepte	All-Tach®
350 l	143 kg	470 mm	1525 mm	841 mm	N736003

Verplichte uitrusting van machines : ✕



Standaard graafbak (compacte machines) - BS 1550 / 360

Capaciteit van de koepel	Gewicht	Totale hoogte	Breedte	Diepte	All-Tach®
360 l	150 kg	470 mm	1550 mm	841 mm	N736065

Verplichte uitrusting van machines : ✕

BAKKEN

Standaard graafbak met tanden (compacte machines)

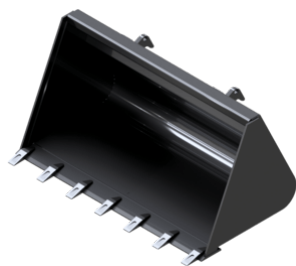

Standaard graafbak met tanden (compacte machines) - BS 1380 / 320 T

Capaciteit van de koepel	Gewicht	Totale hoogte	Breedte	Diepte	All-Tach®
320 l	137 kg	470 mm	1380 mm	841 mm	N736005

Verplichte uitrusting van machines : ✕

Standaard graafbak met tanden (compacte machines) - BS 1480 / 340 T

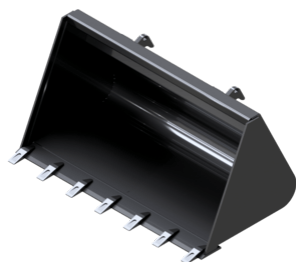

Capaciteit van de koepel	Gewicht	Totale hoogte	Breedte	Diepte	All-Tach®
340 l	141 kg	470 mm	1480 mm	841 mm	N736062

Verplichte uitrusting van machines : ✕

Standaard graafbak met tanden (compacte machines) - BS 1520 / 350 T

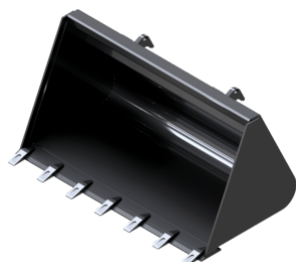

Capaciteit van de koepel	Gewicht	Totale hoogte	Breedte	Diepte	All-Tach®
350 l	143 kg	470 mm	1520 mm	841 mm	N736006

Verplichte uitrusting van machines : ✕

Standaard graafbak met tanden (compacte machines) - BS 1550 / 360 T

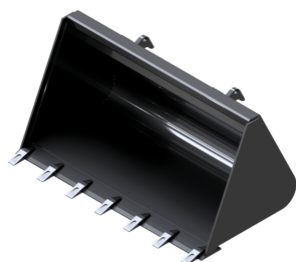

Capaciteit van de koepel	Gewicht	Totale hoogte	Breedte	Diepte	All-Tach®
360 l	150 kg	470 mm	1550 mm	841 mm	N736066

Verplichte uitrusting van machines : ✕

VORKDRAGERS

Palletvorken compleet (compacte machines)



Palletvorken compleet (compacte machines) - CAT 1220 / 1000 (a)

Capaciteit	Totale hoogte	Lengte vorken	Breedte	Diepte
1000 kg	890 mm	1000 mm	1212 mm	1318 mm

Verplichte uitrusting van machines : ✕

VORKEN EN GRIJPERS

Mestvork (compacte machines)

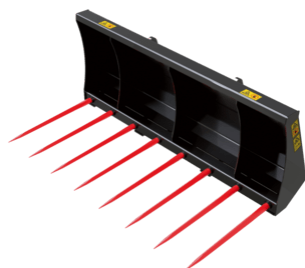

Mestvork (compacte machines) - FM 1400

Gewicht	Totale hoogte	Breedte	Diepte	All-Tach®
160 kg	595 mm	1400 mm	893 mm	N736026

Verplichte uitrusting van machines : ✕

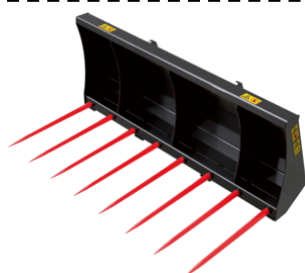

Mestvork (compacte machines) - FM 1520

Gewicht	Totale hoogte	Breedte	Diepte	All-Tach®
170 kg	575 mm	1520 mm	893 mm	N736027

Verplichte uitrusting van machines : ✕

VORKEN EN GRIJPERS

Mestvork met klem (compacte machines)



Mestvork met klem (compacte machines) - FMG 1400 / 380

Capaciteit van de koepel	Gewicht	Totale hoogte	Breedte	Diepte	All-Tach®
380 l	150 kg	746 mm	1400 mm	848 mm	N736029

Verplichte uitrusting van machines :



Mestvork met klem (compact machines) - FMG 1500 / 380

Capaciteit van de koepel	Gewicht	Totale hoogte	Breedte	Diepte	All-Tach®
380 l	165 kg	746 mm	1500 mm	848 mm	N736030

Verplichte uitrusting van machines : 

VEEGMACHINES

Orienteerbare borstel (compacte machines)



Orienteerbare borstel (compacte machines) - SCA 1750

Gewicht	Totale hoogte	Breedte	Diepte	All-Tach®
390 kg	684 mm	1753 mm	1331 mm	N51502366

Verplichte uitrusting van machines : 



Orienteerbare borstel (compacte machines) - SCA 1900

Gewicht	Totale hoogte	Breedte	Diepte	All-Tach®
400 kg	684 mm	1908 mm	1331 mm	N51502367

Verplichte uitrusting van machines : 

VEEGMACHINES

Veegbak (compacte machines)

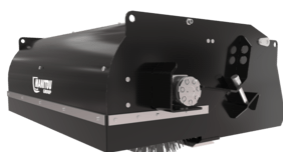

Veegbak (compacte machines) - SCB 1370

Gewicht	Totale hoogte	Breedte	Diepte	All-Tach®
310 kg	652 mm	1631 mm	1222 mm	N736038

Verplichte uitrusting van machines : 

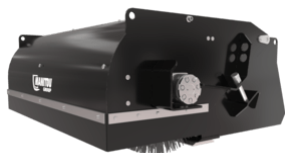

Veegbak (compact machines) - SCB 1525 (b)

Gewicht	Totale hoogte	Breedte	Diepte	All-Tach®
346 kg	652 mm	1786 mm	1222 mm	N736039

Verplichte uitrusting van machines :

EARTH DRILLING AND DIGGING SOLUTIONS

Hydraulische hamer (Compact machines)



Hydraulische hamer (Compact machines) - H 88

Gewicht	Totale hoogte	Diameter minimum	All-Tach® Narrow
88 kg	773 mm	47.90 mm	N51502209

Verplichte uitrusting van machines :



Hydraulische hamer (Compact machines) - H 90

Gewicht	Totale hoogte	Diameter minimum	All-Tach®
88 kg	773 mm	47.90 mm	N51502209

Verplichte uitrusting van machines :



Hydraulische hamer (Compact machines) - H 160

Gewicht	Totale hoogte	Diameter minimum	All-Tach®
162 kg	932 mm	53.70 mm	N51502210

Verplichte uitrusting van machines :



Hydraulische hamer (Compacte machines) - H 162

Gewicht	Totale hoogte	Diameter minimum	All-Tach® Narrow
162 kg	932 mm	53.70 mm	N51502210

Verplichte uitrusting van machines : 

SNOW REMOVING SOLUTIONS

Sneeuwschuiver (compacte machines)



Sneeuwschuiver (compacte machines) - BLS 1800 / 900

Gewicht	Totale hoogte	Breedte	Diepte	All-Tach®
280 kg	700 mm	1800 mm	900 mm	N51502224

Verplichte uitrusting van machines :  + 

LEVELLING SOLUTIONS

Hydr. Dozer blad (compacte machines)



Hydr. Dozer blad (compacte machines) - BLD 1480 H

Gewicht	Totale hoogte	Breedte	Diepte	All-Tach®
230 kg	677 mm	1480 mm	813 mm	N736037

LEVELLING SOLUTIONS

Manueel Dozer blad (compacte machines)



Manueel Dozer blad (compacte machines) - BLD 1480

Gewicht	Totale hoogte	Breedte	Diepte	All-Tach®
185 kg	677 mm	1480 mm	813 mm	N736036

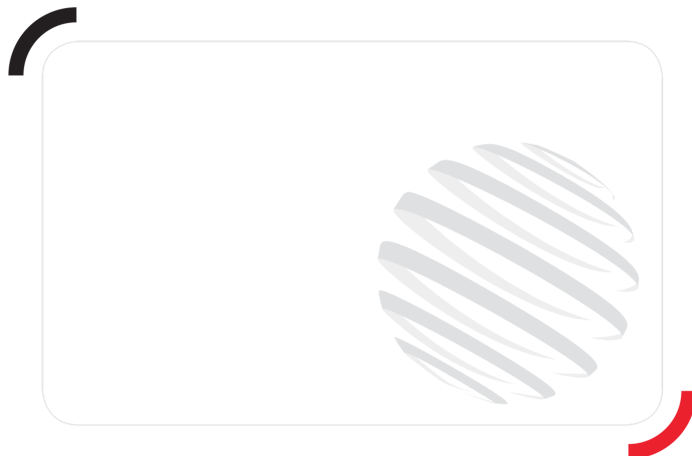

Hoofdkantoor

B.P. 249 - 430 rue de l'Aubinière

44150 Ancenis Cedex - Frankrijk

Tel.: 00 33 (0)2 40 09 10 11 - Fax: 00 33 (0)2 40 09 10 97

www.manitou.com



Deze brochure beschrijft versies en configuratie-opties voor Manitou-producten die met verschillende apparatuur kunnen worden uitgerust. De uitrusting die in deze brochure wordt beschreven, kan standaard, optioneel of niet leverbaar zijn, afhankelijk van de uitvoering. Manitou behoudt zich het recht voor om de weergegeven en beschreven specificaties op elk moment en zonder kennisgeving vooraf te wijzigen. De fabrikant is niet aansprakelijk voor de gegeven specificaties. Neem voor meer informatie contact op met uw Manitou-dealer. Niet-contractueel document. De productbeschrijvingen kunnen afwijken van de werkelijke producten. De lijst met specificaties is niet allesomvattend. De logo's en visuele identiteit van het bedrijf zijn eigendom van Manitou en mogen niet zonder toestemming worden gebruikt. Alle rechten voorbehouden. De foto's en diagrammen in deze brochure zijn uitsluitend bedoeld voor raadpleging en informatie.
MANITOU BF SA - Naamloze vennootschap met raad van bestuur - Aandeelkapitaal: 39.668.399 euro - 857 802 508 RCS Nantes