

Nederlands

Schranklader

Compact Track loaders

2100VT

MACHINEBOOK



Hoedanigheid		Metrisch
Rated Operating Capacity		952.54 kg
Operating Capacity At 50% Tipping Load		1360.77 kg
Rated Operating Capacity with Optional Counterweight		997.90 kg
Operating Weight		4021 kg
Leeg gewicht		3651 kg
Tipping capacity		2721 kg
Gewicht en afmetingen		
Overall Operating Height - Fully Raised	h27	4026 mm
Hoogte tot schamierpen - volledig verhoogd	h28	3073 mm
Overall Height to top of ROPS	h17	2045 mm
Storhoek op volledige hoogte	a5	42 °
Dump height	h29	2300 mm
Overall length with bucket	l16	3543 mm
Dump reach - Full height	r6	927 mm
Terugdraaihoek op volledige hoogte	a4	92 °
Seat to ground height	h30	965 mm
Overall width less bucket	b1	1674 mm
Bodemvrijheid machine	m4	191 mm
Overall length - Less Bucket	l2	2743 mm
Clearance Radius - Front with Bucket	b18	2210 mm
Rear departure angle		25 °
Prestatie		
Rijsnelheid (onbelast)		10.30 km/h
Travel Speed with Two-Speed Option - Maximum		15.30 km/h
Banden		
Type		Hydrostatisch
Motor		
Merk		Yanmar
Motormodel		4TNV98C-NGL
Motormom		Stage V
Gross Power		51.70 kW
Net Power		51 kW
Max. koppel / Motorkoppel		241 Nm / 1625 rpm
Stroombron		Diesel
Aantal cilinders		4
I.C. Motorvermogen		69.30 Hp
Motorkoelingssysteem		Water
Batterij		12 V
Alternator - Ampere		100 A
Starter		3 kW
Hydraulisch		
Hulphydrauliek		86.50 l/min
Auxiliary Hydraulic Pressure		239.59 bar
High-Flow Auxiliary Hydraulics - Option		114 l/min
High-Flow Auxiliary Hydraulics Pressure - Option		229.25 bar
Tankinhoud		
Inhoud brandstoftank		143.80 l
Inhoud hydraulische tank		22.70 l
Cilinderinhoud		3.30 l

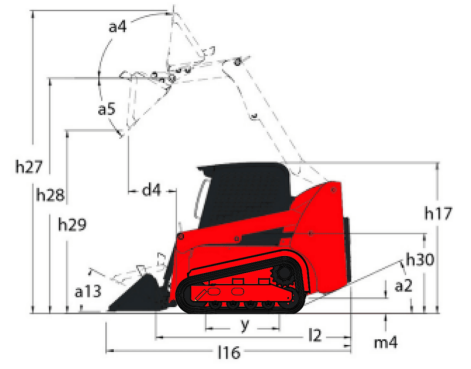
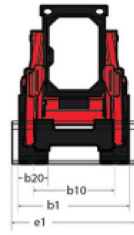
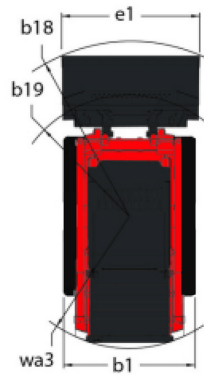

BAKKEN

4-in-1 bak (compacte machines)**4-in-1 bak (compacte machines) - B4x1 1680 / 430**

Capaciteit van de koepel	Gewicht	Totale hoogte	Breedte	Diepte	All-Tach®
430 l	350 kg	767 mm	1680 mm	786 mm	N51502041

Verplichte uitrusting van machines : 

**4-in-1 bak (compacte machines) - B4x1 1760 / 450**

Capaciteit van de koepel	Gewicht	Totale hoogte	Breedte	Diepte	All-Tach®
450 l	410 kg	767 mm	1760 mm	786 mm	N51502042

Verplichte uitrusting van machines : 

**4-in-1 bak (compacte machines) - B4x1 1850 / 480**

Capaciteit van de koepel	Gewicht	Totale hoogte	Breedte	Diepte	All-Tach®
480 l	420 kg	767 mm	1850 mm	786 mm	N51502043

Verplichte uitrusting van machines : 

BAKKEN

4-in-1 bak met tanden(compacte machines)**4-in-1 bak met tanden(compacte machines) - B4x1 1680 / 430 T**

Capaciteit van de koepel	Gewicht	Totale hoogte	Breedte	Diepte	All-Tach®
430 l	350 kg	767 mm	1680 mm	786 mm	N51502045

Verplichte uitrusting van machines : 



4-in-1 bak met tanden(compacte machines) - B4x1 1760 / 450 T

Capaciteit van de koepel	Gewicht	Totale hoogte	Breedte	Diepte	All-Tach®
450 l	410 kg	767 mm	1760 mm	786 mm	N51502046

Verplichte uitrusting van machines : 



4-in-1 bak met tanden(compacte machines) - B4x1 1850 / 480 T

Capaciteit van de koepel	Gewicht	Totale hoogte	Breedte	Diepte	All-Tach®
480 l	420 kg	767 mm	1850 mm	786 mm	N51502047

Verplichte uitrusting van machines : 



4-in-1 bak met tanden(compacte machines) - B4x1 1880 / 480 T

Capaciteit van de koepel	Gewicht	Totale hoogte	Breedte	Diepte	All-Tach®
480 l	420 kg	767 mm	1880 mm	786 mm	N51502083

Verplichte uitrusting van machines : 

BAKKEN

Allroundbak (compacte machines)

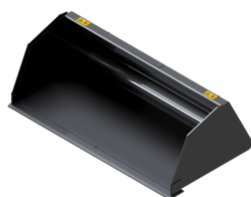

Allroundbak (compacte machines) - BU 1760 / 830

Capaciteit	Capaciteit van de koepel	Totale hoogte	Breedte	Diepte	All-Tach®
1245 kg	830 l	732 mm	1760 mm	1055 mm	N51502034

Verplichte uitrusting van machines : 

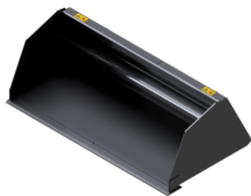

Allroundbak (compact machines) - BU 1850 / 900

Capaciteit	Capaciteit van de koepel	Totale hoogte	Breedte	Diepte	All-Tach®
1350 kg	900 l	732 mm	1850 mm	1055 mm	N51502035

Verplichte uitrusting van machines : ✕

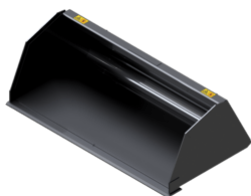

Allroundbak (compact machines) - BU 2080 / 1010

Capaciteit	Capaciteit van de koepel	Gewicht	Totale hoogte	Breedte	Diepte
1515 kg	1010 l	370 kg	732 mm	2080 mm	1055 mm

All-Tach®
N51502075

Verplichte uitrusting van machines : ✕

BAKKEN

Groot volumebak (compact machines)



Groot volumebak (compact machines) - BLM 1680 / 670

Capaciteit	Capaciteit van de koepel	Gewicht	Totale hoogte	Breedte	Diepte
670 kg	670 l	242 kg	605 mm	1680 mm	1023 mm

All-Tach®
N747011

Verplichte uitrusting van machines : ✕



Groot volumebak (compact machines) - BLM 1850 / 1100

Capaciteit	Capaciteit van de koepel	Gewicht	Totale hoogte	Breedte	Diepte
1100 kg	1100 l	350 kg	832 mm	1850 mm	1102 mm

All-Tach®
N51502037

Verplichte uitrusting van machines : ✕

BAKKEN

Industriële klem (compacte machines)



Industriële klem (compacte machines) - BGI 1680 / 560 (b)

Capaciteit van de koepel	Gewicht	Breedte	Gesloten grijphoogte	Diepte	All-Tach®
560 l	400 kg	1680 mm	761 mm	1007 mm	N51502063

Verplichte uitrusting van machines : 

BAKKEN

Sloopbak met hoge weerstand (Compacte machines)

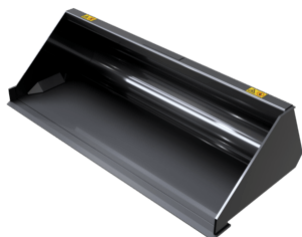

Sloopbak met hoge weerstand (Compacte machines) - BD 1680 / 670

Capaciteit van de koepel	Gewicht	Totale hoogte	Breedte	Diepte	All-Tach®
670 l	295 kg	600 mm	1680 mm	1100 mm	N51502029

Verplichte uitrusting van machines : 

Sloopbak met hoge weerstand (Compacte machines) - BD 1760 / 700

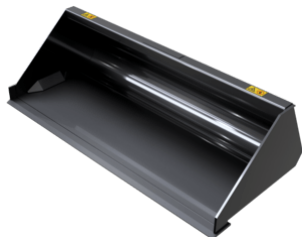

Capaciteit van de koepel	Gewicht	Totale hoogte	Breedte	Diepte	All-Tach®
700 l	305 kg	600 mm	1760 mm	1100 mm	N51502030

Verplichte uitrusting van machines : 

Sloopbak met hoge weerstand (Compacte machines) - BD 1850 / 740

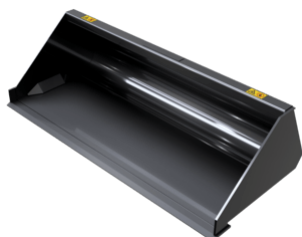

Capaciteit van de koepel	Gewicht	Totale hoogte	Breedte	Diepte	All-Tach®
740 l	315 kg	600 mm	1850 mm	1100 mm	N51502031

Verplichte uitrusting van machines : 

BAKKEN

Standaard graafbak (compacte machines)**Standaard graafbak (compacte machines) - BS 1680 / 400**

Capaciteit van de koepel	Gewicht	Totale hoogte	Breedte	Diepte	All-Tach®
400 l	148 kg	450 mm	1680 mm	843 mm	N747002

Verplichte uitrusting van machines : ✕

Standaard graafbak (compacte machines) - BS 1760 / 580

Capaciteit van de koepel	Gewicht	Totale hoogte	Breedte	Diepte	All-Tach®
500 l	190 kg	502 mm	1760 mm	924 mm	N748001

Verplichte uitrusting van machines : ✕

BAKKEN

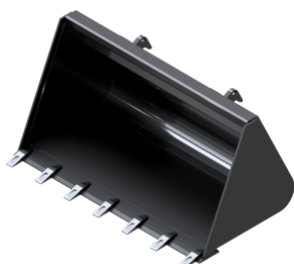
Standaard graafbak met tanden (compacte machines)**Standaard graafbak met tanden (compacte machines) - BS 1680 / 670 T**

Capaciteit van de koepel	Gewicht	Totale hoogte	Breedte	Diepte	All-Tach®
670 l	295 kg	600 mm	1680 mm	1100 mm	N51502025

Verplichte uitrusting van machines : ✕

VORKEN EN GRIJPERS

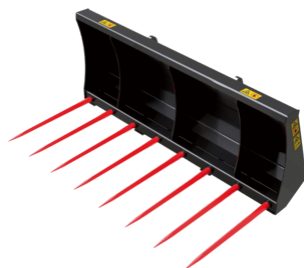
Mestvork (compacte machines)**Mestvork (compacte machines) - FM 1680**

Gewicht	Totale hoogte	Breedte	Diepte	All-Tach®
134 kg	600 mm	1680 mm	870 mm	N747023

Verplichte uitrusting van machines : ✕

VORKEN EN GRIJPERS

Mestvork met klem (compacte machines)**Mestvork met klem (compacte machines) - FMG 1680 / 600 (b)**

Capaciteit van de koepel	Gewicht	Totale hoogte	Breedte	Diepte	All-Tach®
600 l	240 kg	796 mm	1680 mm	1028 mm	N51502056

Verplichte uitrusting van machines :

**Mestvork met klem (compacte machines) - FMG 1760 / 620 (b)**

Capaciteit van de koepel	Gewicht	Totale hoogte	Breedte	Diepte	All-Tach®
620 l	250 kg	796 mm	1760 mm	1028 mm	N51502057

Verplichte uitrusting van machines :

**Mestvork met klem (compacte machines) - FMG 1850 / 660 (c)**

Capaciteit van de koepel	Gewicht	Totale hoogte	Breedte	Diepte	All-Tach®
660 l	280 kg	796 mm	1850 mm	1028 mm	N51502058

Verplichte uitrusting van machines :

SNOW REMOVING SOLUTIONS

Sneeuwblazer (compacte machines)**Sneeuwblazer (compacte machines) - SBL 1800**

Gewicht	Totale hoogte	Breedte	Diameter 1	Diameter 2	All-Tach®
480 kg	1500 mm	1800 mm	450 mm	420 mm	N51502228

Verplichte uitrusting van machines : + +

**Sneeuwblazer (compacte machines) - SBL 2100**

Gewicht	Totale hoogte	Breedte	Diameter 1	Diameter 2	All-Tach®
540 kg	2100 mm	2100 mm	450 mm	420 mm	N51502229

Verplichte uitrusting van machines :  +  + 

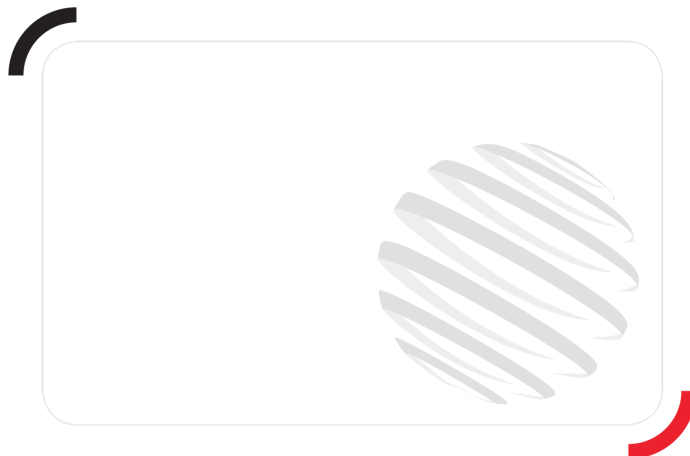

Hoofdkantoor

B.P. 249 - 430 rue de l'Aubinière

44150 Ancenis Cedex - Frankrijk

Tel.: 00 33 (0)2 40 09 10 11 - Fax: 00 33 (0)2 40 09 10 97

www.manitou.com



Deze brochure beschrijft versies en configuratie-opties voor Manitou-producten die met verschillende apparatuur kunnen worden uitgerust. De uitrusting die in deze brochure wordt beschreven, kan standaard, optioneel of niet leverbaar zijn, afhankelijk van de uitvoering. Manitou behoudt zich het recht voor om de weergegeven en beschreven specificaties op elk moment en zonder kennisgeving vooraf te wijzigen. De fabrikant is niet aansprakelijk voor de gegeven specificaties. Neem voor meer informatie contact op met uw Manitou-dealer. Niet-contractueel document. De productbeschrijvingen kunnen afwijken van de werkelijke producten. De lijst met specificaties is niet allesomvattend. De logo's en visuele identiteit van het bedrijf zijn eigendom van Manitou en mogen niet zonder toestemming worden gebruikt. Alle rechten voorbehouden. De foto's en diagrammen in deze brochure zijn uitsluitend bedoeld voor raadpleging en informatie.
MANITOU BF SA - Naamloze vennootschap met raad van bestuur - Aandeelkapitaal: 39.668.399 euro - 857 802 508 RCS Nantes