

Nederlands

Schranklader

Skid Steer Loaders

# 2750V

## MACHINEBOOK



 **MANITOU**  
HANDLING YOUR WORLD

Hoedanigheid		Metrisch
Operating Capacity At 50% Tipping Load		1247.37 kg
Operating Weight		3774 kg
Leeg gewicht		3426 kg
Tipping capacity		2495 kg
Gewicht en afmetingen		
Wielbasis (y)	y	1219 mm
Overall Operating Height - Fully Raised	h27	4252 mm
Hoogte tot schamierpen - volledig verhoogd	h28	3277 mm
Overall Height to top of ROPS	h17	2058 mm
Storhoek op volledige hoogte	a5	42 °
Dump height	h29	2489 mm
Overall length with bucket	l16	3810 mm
Dump reach - Full height	r6	830 mm
Terugdraaihoek op volledige hoogte	a4	92 °
Seat to ground height	h30	978 mm
Overall width less bucket	b1	1712 mm
Bodemvrijheid machine	m4	216 mm
Overall length - Less Bucket	l2	3023 mm
Clearance Radius - Front with Bucket	b18	2289 mm
Rear departure angle		30 °
Prestatie		
Rijsnelheid (onbelast)		11.40 km/h
Travel Speed with Two-Speed Option - Maximum		17.50 km/h
Banden		
Type		Hydrostatisch
Motor		
Merk		Yanmar
Motomodel		4TNV98CTXNGL
Motomom		Stage V
Gross Power		53.70 kW
Net Power		52.70 kW
Max. koppel / Motorkoppel		294 Nm / 1800 rpm
Stroombron		Diesel
Aantal cilinders		4
I.C. Motorvermogen		72 Hp
Motorkoelingsysteem		Water
Batterij		12 V
Alternator - Ampere		100 A
Starter		3 kW
Hydraulisch		
Hulphydrauliek		98.40 l/min
Auxiliary Hydraulic Pressure		239.59 bar
High-Flow Auxiliary Hydraulics - Option		126 l/min
High-Flow Auxiliary Hydraulics Pressure - Option		229.25 bar
Tankinhoud		
Inhoud brandstoftank		106 l
Inhoud hydraulische tank		22.70 l
Cilinderinhoud		3.30 l
Volume van de vloeistofkoeltank		18 l

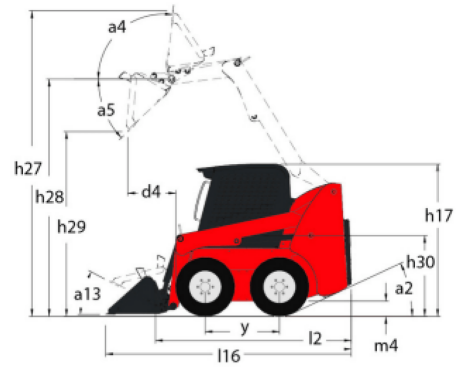
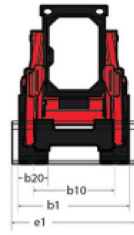
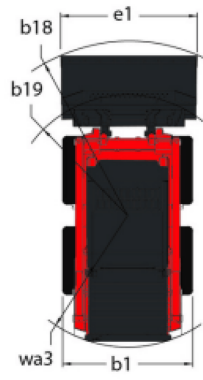

## BAKKEN

## 4-in-1 bak (compacte machines)



## 4-in-1 bak (compacte machines) - B4x1 1760 / 420

Capaciteit van de koepel	Gewicht	Totale hoogte	Breedte	Diepte	All-Tach®
420 l	385 kg	767 mm	1760 mm	800 mm	N51502476

Verplichte uitrusting van machines : 



## 4-in-1 bak (compacte machines) - B4x1 1830 / 450 (a)

Capaciteit van de koepel	Gewicht	Totale hoogte	Breedte	Diepte	All-Tach®
450 l	420 kg	767 mm	1830 mm	880 mm	N757024

Verplichte uitrusting van machines : 



## 4-in-1 bak (compacte machines) - B4x1 1830 / 450 (b)

Capaciteit van de koepel	Gewicht	Totale hoogte	Breedte	Diepte	All-Tach®
450 l	420 kg	767 mm	1830 mm	800 mm	N51502478

Verplichte uitrusting van machines : 



## 4-in-1 bak (compacte machines) - B4x1 1880 / 480

Capaciteit van de koepel	Gewicht	Totale hoogte	Breedte	Diepte	All-Tach®
480 l	420 kg	767 mm	1880 mm	786 mm	N51502082

Verplichte uitrusting van machines : 

## BAKKEN

## 4-in-1 bak met tanden(compacte machines)



## 4-in-1 bak met tanden(compacte machines) - B4x1 1760 / 420 T

Capaciteit van de koepel	Gewicht	Totale hoogte	Breedte	Diepte	All-Tach®
420 l	385 kg	767 mm	1760 mm	800 mm	N51502477

Verplichte uitrusting van machines : 



## 4-in-1 bak met tanden(compacte machines) - B4x1 1830 / 450 T (a)

Capaciteit van de koepel	Gewicht	Totale hoogte	Breedte	Diepte	All-Tach®
450 l	420 kg	767 mm	1830 mm	800 mm	N757025

Verplichte uitrusting van machines : 



## 4-in-1 bak met tanden(compacte machines) - B4x1 1830 / 450 T (b)

Capaciteit van de koepel	Gewicht	Totale hoogte	Breedte	Diepte	All-Tach®
450 l	420 kg	767 mm	1830 mm	800 mm	N51502479

Verplichte uitrusting van machines : 



## 4-in-1 bak met tanden(compacte machines) - B4x1 1880 / 480 T

Capaciteit van de koepel	Gewicht	Totale hoogte	Breedte	Diepte	All-Tach®
480 l	420 kg	767 mm	1880 mm	786 mm	N51502083

Verplichte uitrusting van machines : 

## BAKKEN

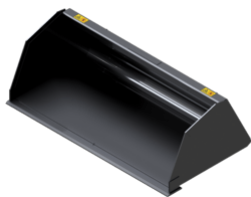
**Allroundbak (compacte machines)****Allroundbak (compacte machines) - BU 1760 / 690**

Capaciteit	Capaciteit van de koepel	Gewicht	Totale hoogte	Breedte	Diepte
1035 kg	690 l	255 kg	645 mm	1760 mm	952 mm
All-Tach®					
N757009					

Verplichte uitrusting van machines : ✕

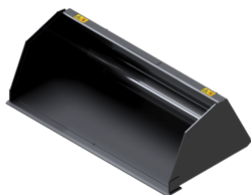
**Allroundbak (compacte machines) - BU 1760 / 740**

Capaciteit	Capaciteit van de koepel	Gewicht	Totale hoogte	Breedte	Diepte
1110 kg	740 l	210 kg	670 mm	1760 mm	960 mm
All-Tach®					
N51502466					

Verplichte uitrusting van machines : ✕

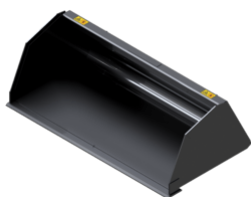
**Allroundbak (compacte machines) - BU 1880 / 900**

Capaciteit	Capaciteit van de koepel	Gewicht	Totale hoogte	Breedte	Diepte
1350 kg	900 l	360 kg	732 mm	1880 mm	1055 mm
All-Tach®					
N51502074					

Verplichte uitrusting van machines : ✕

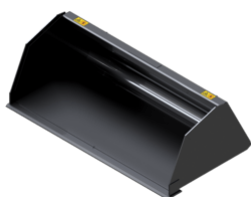
**Allroundbak (compacte machines) - BU 2080 / 1010**

Capaciteit	Capaciteit van de koepel	Gewicht	Totale hoogte	Breedte	Diepte
1515 kg	1010 l	370 kg	732 mm	2080 mm	1055 mm
All-Tach®					
N51502075					

Verplichte uitrusting van machines : ✕

## BAKKEN

## Groot volumebak (compacte machines)



## Groot volumebak (compacte machines) - BLM 1760 / 790

Capaciteit	Capaciteit van de koepel	Gewicht	Totale hoogte	Breedte	Diepte
820 kg	820 l	275 kg	711 mm	1760 mm	1020 mm
All-Tach®					
N757013					

Verplichte uitrusting van machines : ✕



## Groot volumebak (compacte machines) - BLM 1850 / 860

Capaciteit	Capaciteit van de koepel	Gewicht	Totale hoogte	Breedte	Diepte
830 kg	830 l	275 kg	705 mm	1850 mm	1012 mm
All-Tach®					
N51502469					

Verplichte uitrusting van machines : ✕



## Groot volumebak (compacte machines) - BLM 2080 / 1250

Capaciteit	Capaciteit van de koepel	Gewicht	Totale hoogte	Breedte	Diepte
1250 kg	1250 l	370 kg	832 mm	2080 mm	1102 mm
All-Tach®					
N51502076					

Verplichte uitrusting van machines : ✕

## BAKKEN

## Industriële klem (compacte machines)



## Industriële klem (compacte machines) - BGI 1760 / 600

Capaciteit van de koepel	Gewicht	Breedte	Gesloten grijphoogte	Diepte	All-Tach®
600 l	440 kg	1760 mm	761 mm	1007 mm	N51502474

Verplichte uitrusting van machines : ☺☺



**Industriële klem (compacte machines) - BGI 1850 / 620 (a)**

Capaciteit van de koepel	Gewicht	Breedte	Gesloten grijphoogte	Diepte	All-Tach®
620 l	455 kg	1850 mm	761 mm	1007 mm	N757021

Verplichte uitrusting van machines : 



**Industriële klem (compacte machines) - BGI 1850 / 620 (b)**

Capaciteit van de koepel	Gewicht	Breedte	Gesloten grijphoogte	Diepte	All-Tach®
620 l	455 kg	1850 mm	761 mm	1007 mm	N51502475

Verplichte uitrusting van machines : 

**BAKKEN**

**Sloopbak met hoge weerstand (Compacte machines)**

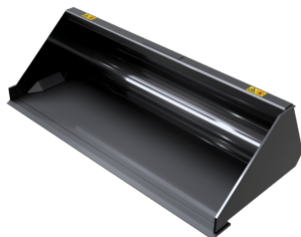

**Sloopbak met hoge weerstand (Compacte machines) - BD 1760 / 580**

Capaciteit van de koepel	Gewicht	Totale hoogte	Breedte	Diepte	All-Tach®
500 l	190 kg	502 mm	1760 mm	924 mm	N757007

Verplichte uitrusting van machines : 

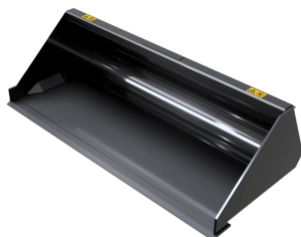

**Sloopbak met hoge weerstand (Compacte machines) - BD 1830 / 520**

Capaciteit van de koepel	Gewicht	Totale hoogte	Breedte	Diepte	All-Tach®
600 l	220 kg	501 mm	1830 mm	916 mm	N51502465

Verplichte uitrusting van machines : 



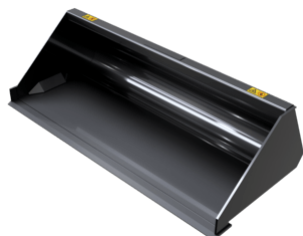

### Sloopbak met hoge weerstand (Compacte machines) - BD 1830 / 600

Capaciteit van de koepel	Gewicht	Totale hoogte	Breedte	Diepte	All-Tach®
520 l	206 kg	502 mm	1830 mm	924 mm	N757008

Verplichte uitrusting van machines : ✕

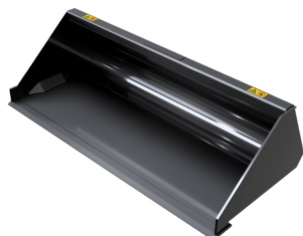

### Sloopbak met hoge weerstand (Compacte machines) - BD 1880 / 750

Capaciteit van de koepel	Gewicht	Totale hoogte	Breedte	Diepte	All-Tach®
750 l	315 kg	600 mm	1880 mm	1100 mm	N51502073

Verplichte uitrusting van machines : ✕

## BAKKEN

### Standaard graafbak (compacte machines)



#### Standaard graafbak (compacte machines) - BS 1760 / 580

Capaciteit van de koepel	Gewicht	Totale hoogte	Breedte	Diepte	All-Tach®
500 l	190 kg	502 mm	1760 mm	924 mm	N748001

Verplichte uitrusting van machines : ✕



#### Standaard graafbak (compacte machines) - BS 1830 / 600

Capaciteit van de koepel	Gewicht	Totale hoogte	Breedte	Diepte	All-Tach®
520 l	206 kg	502 mm	1830 mm	924 mm	N757073

Verplichte uitrusting van machines : ✕



### Standaard graafbak (compacte machines) - BS 1880 / 750

Capaciteit van de koepel	Gewicht	Totale hoogte	Breedte	Diepte	All-Tach®
750 l	315 kg	600 mm	1880 mm	1100 mm	N51502071

Verplichte uitrusting van machines : ✕

## BAKKEN

### Standaard graafbak met tanden (compacte machines)

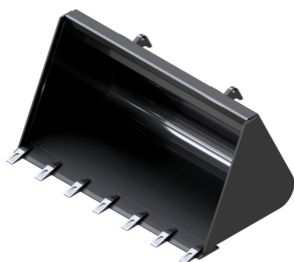

#### Standaard graafbak met tanden (compacte machines) - BS 1760 / 580 T

Capaciteit van de koepel	Gewicht	Totale hoogte	Breedte	Diepte	All-Tach®
500 l	190 kg	502 mm	1760 mm	924 mm	N748002

Verplichte uitrusting van machines : ✕

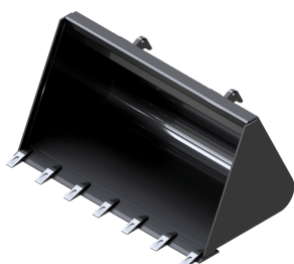

#### Standaard graafbak met tanden (compacte machines) - BS 1830 / 600 T

Capaciteit van de koepel	Gewicht	Totale hoogte	Breedte	Diepte	All-Tach®
520 l	206 kg	502 mm	1830 mm	924 mm	N757074

Verplichte uitrusting van machines : ✕

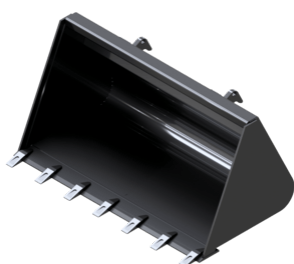

#### Standaard graafbak met tanden (compacte machines) - BS 1880 / 750 T

Capaciteit van de koepel	Gewicht	Totale hoogte	Breedte	Diepte	All-Tach®
750 l	315 kg	600 mm	1880 mm	1100 mm	N51502072

Verplichte uitrusting van machines : ✕

## VORKEN EN GRIJPERS

**Balenvork (compacte machines)****Balenvork (compacte machines) - FB 1110**

Capaciteit	Gewicht	Totale hoogte	Totale lengte	Lengte vorken	Breedte
560 kg	75 kg	560 mm	1186 mm	955 mm	1170 mm
Diepte	All-Tach®				
1110 mm	N747028				

Verplichte uitrusting van machines : ✕

## VORKEN EN GRIJPERS

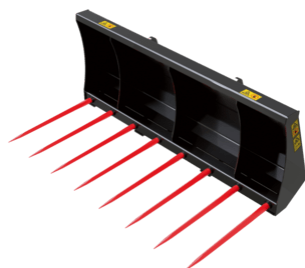
**Mestvork (compacte machines)****Mestvork (compacte machines) - FM 1850 (a)**

Gewicht	Totale hoogte	Breedte	Diepte	All-Tach®
153 kg	600 mm	1850 mm	870 mm	N757031

Verplichte uitrusting van machines : ✕

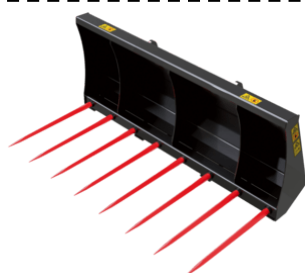
**Mestvork (compacte machines) - FM 1850 (b)**

Gewicht	Totale hoogte	Breedte	Diepte	All-Tach®
153 kg	600 mm	1850 mm	870 mm	N51502480

Verplichte uitrusting van machines : ✕

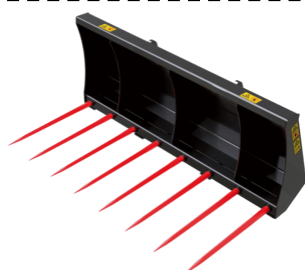
**Mestvork (compacte machines) - FM 1880**

Gewicht	Totale hoogte	Breedte	Diepte	All-Tach®
153 kg	600 mm	1880 mm	870 mm	N51502080

Verplichte uitrusting van machines : ✕

## VORKEN EN GRIJPERS

**Mestvork met klem (compacte machines)****Mestvork met klem (compacte machines) - FMG 1850 / 660 (a)**

Capaciteit van de koepel	Gewicht	Totale hoogte	Breedte	Diepte	All-Tach®
660 l	280 kg	796 mm	1850 mm	1028 mm	N757033

Verplichte uitrusting van machines : 

**Mestvork met klem (compacte machines) - FMG 1880 / 660**

Capaciteit van de koepel	Gewicht	Totale hoogte	Breedte	Diepte	All-Tach®
660 l	280 kg	796 mm	1880 mm	1028 mm	N51502081

Verplichte uitrusting van machines : 

**Mestvork met klem (compacte machines) - FMG 2140 / 760 (a)**

Capaciteit van de koepel	Gewicht	Totale hoogte	Breedte	Diepte	All-Tach®
760 l	310 kg	796 mm	2140 mm	1028 mm	N700261

Verplichte uitrusting van machines : 

## VEEGMACHINES

**Rubberblad (compacte machines)****Rubberblad (compacte machines) - BLSS 1800 (a)**

Gewicht	Totale hoogte	Breedte	Diepte	All-Tach®
124 kg	611 mm	1800 mm	900 mm	N757036

Verplichte uitrusting van machines : 

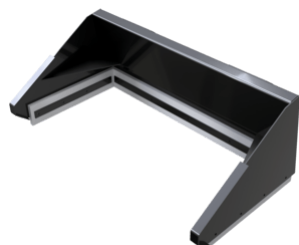

**Rubberblad (compacte machines) - BLSS 1890 (a)**

Gewicht	Totale hoogte	Breedte	Diepte	All-Tach®
138 kg	611 mm	1890 mm	900 mm	N757037

Verplichte uitrusting van machines : ✕

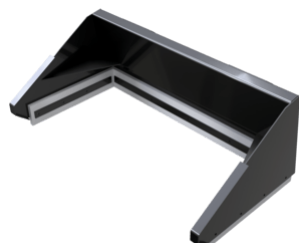

**Rubberblad (compacte machines) - BLSS 1890 (b)**

Gewicht	Totale hoogte	Breedte	Diepte	All-Tach®
138 kg	611 mm	1890 mm	900 mm	N51502499

Verplichte uitrusting van machines : ✕

SNOW REMOVING SOLUTIONS

**Sneeuwblazer (compacte machines)**



**Sneeuwblazer (compacte machines) - SBL 1800**

Gewicht	Totale hoogte	Breedte	Diameter 1	Diameter 2	All-Tach®
480 kg	1500 mm	1800 mm	450 mm	420 mm	N51502228

Verplichte uitrusting van machines : ✕



**Sneeuwblazer (compacte machines) - SBL 2100**

Gewicht	Totale hoogte	Breedte	Diameter 1	Diameter 2	All-Tach®
540 kg	2100 mm	2100 mm	450 mm	420 mm	N51502229

Verplichte uitrusting van machines : ✕

## SNOW REMOVING SOLUTIONS

**Sneeuwschuiver (compacte machines)****Sneeuwschuiver (compacte machines) - BLS 2100 / 900 (a)**

Gewicht	Totale hoogte	Breedte	Diepte	All-Tach®
350 kg	700 mm	2100 mm	900 mm	N51502225

Verplichte uitrusting van machines :  + 

**Sneeuwschuiver (compacte machines) - BLS 2400 / 900 (a)**

Gewicht	Totale hoogte	Breedte	Diepte	All-Tach®
410 kg	800 mm	2400 mm	900 mm	N51502227

Verplichte uitrusting van machines :  + 

## LEVELLING SOLUTIONS

**Hydr. Dozer blad (compacte machines)****Hydr. Dozer blad (compacte machines) - BLD 1800 H (c)**

Gewicht	Totale hoogte	Breedte	Diepte	All-Tach®
305 kg	677 mm	1800 mm	813 mm	N51502491

**Hydr. Dozer blad (compacte machines) - BLD 2000 H (b)**

Gewicht	Totale hoogte	Breedte	Diepte	All-Tach®
305 kg	677 mm	2000 mm	813 mm	N51502492

## LEVELLING SOLUTIONS

**Manueel Dozer blad (compacte machines)****Manueel Dozer blad (compacte machines) - BLD 2000 (a)**

Gewicht	Totale hoogte	Breedte	Diepte	All-Tach®
288 kg	677 mm	2000 mm	813 mm	N51502489

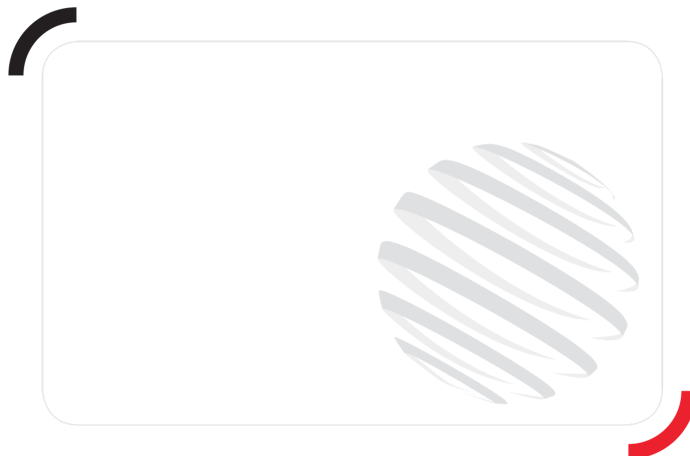

**Hoofdkantoor**

B.P. 249 - 430 rue de l'Aubinière

44150 Ancenis Cedex - Frankrijk

Tel.: 00 33 (0)2 40 09 10 11 - Fax: 00 33 (0)2 40 09 10 97

[www.manitou.com](http://www.manitou.com)



Deze brochure beschrijft versies en configuratie-opties voor Manitou-producten die met verschillende apparatuur kunnen worden uitgerust. De uitrusting die in deze brochure wordt beschreven, kan standaard, optioneel of niet leverbaar zijn, afhankelijk van de uitvoering. Manitou behoudt zich het recht voor om de weergegeven en beschreven specificaties op elk moment en zonder kennisgeving vooraf te wijzigen. De fabrikant is niet aansprakelijk voor de gegeven specificaties. Neem voor meer informatie contact op met uw Manitou-dealer. Niet-contractueel document. De productbeschrijvingen kunnen afwijken van de werkelijke producten. De lijst met specificaties is niet allesomvattend. De logo's en visuele identiteit van het bedrijf zijn eigendom van Manitou en mogen niet zonder toestemming worden gebruikt. Alle rechten voorbehouden. De foto's en diagrammen in deze brochure zijn uitsluitend bedoeld voor raadpleging en informatie.  
MANITOU BF SA - Naamloze vennootschap met raad van bestuur - Aandeelkapitaal: 39.668.399 euro - 857 802 508 RCS Nantes