

Nederlands

Schranklader

Skid Steer Loaders

# **3300V NXT2**

## MACHINEBOOK



<b>Hoedanigheid</b>		<b>Metrisch</b>
Rated Operating Capacity		1497 kg
Leeg gewicht		4123 kg
<b>Gewicht en afmetingen</b>		
Wielbasis (y)	y	1257 mm
Overall Operating Height - Fully Raised	h27	4369 mm
Hoogte tot scharnierpen - volledig verhoogd	h28	3332 mm
Overall Height to top of ROPS	h17	2083 mm
Stortheok op volledige hoogte	a5	42 °
Dump height	h29	2502 mm
Overall length with bucket	l16	3874 mm
Dump reach - Full height	r6	813 mm
Terugrollen op de grond	a13	29 °
Seat to ground height	h30	1041 mm
Overall width less bucket	b1	1829 mm
Bakbreedte	e1	1880 mm
Bodemwrijheid machine	m4	229 mm
Overall length - Less Bucket	l2	3023 mm
Starthoek	a2	25 °
Clearance Radius - Front with Bucket	b18	2400 mm
<b>Prestatie</b>		
Rijsnelheid (onbelast)		13 km/h
Travel Speed with Two-Speed Option - Maximum		19.60 km/h
<b>Banden</b>		
Modellen banden		14.00 x 17.5 HD
<b>Motor</b>		
Merk		Yanmar
Motomodel		4TNV98CT-NMS
Motomom		Stage V
Gross Power		53.70 kW
Net Power		52.70 kW
Max. koppel / Motorkoppel		294 Nm / 2500 rpm
Stroombron		Diesel
I.C. Motorvermogen		72 Hp
Batterij		12 V
Alternator		95 kW
Starter		3 kW
<b>Hydraulisch</b>		
Hulphdrauliek		89.10 l/min
Auxiliary Hydraulic Pressure		237.90 bar
High-Flow Auxiliary Hydraulics - Option		132 l/min
High-Flow Auxiliary Hydraulics Pressure - Option		220.60 bar
<b>Tankinhoud</b>		
Inhoud brandstoftank		92.70 l
Inhoud hydraulische tank		40 l
Cilinderinhoud		3.30 l
<b>Geluid en trillingen</b>		
Lawaai in de omgeving (LwA)		101 dB
Lawaai op de bestuurdersplaats (LpA)		85 dB
Whole-Body Vibration (ISO 2631-1)		0.79 m/s <sup>2</sup>
Trillingen op het geheel handen/armen		< 1.20 m/s <sup>2</sup>

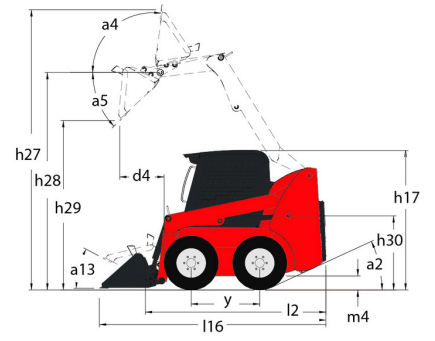
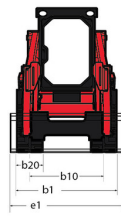
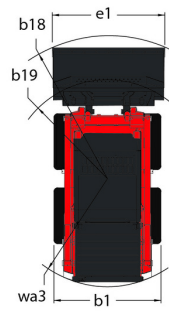

BAKKEN

**4-in-1 bak (compacte machines)**



**4-in-1 bak (compacte machines) - B4x1 1830 / 450 (a)**

Capaciteit van de koepel	Gewicht	Totale hoogte	Breedte	Diepte	All-Tach®
450 l	420 kg	767 mm	1830 mm	880 mm	N757024

Verplichte uitrusting van machines : 



**4-in-1 bak (compacte machines) - B4x1 1880 / 480**

Capaciteit van de koepel	Gewicht	Totale hoogte	Breedte	Diepte	All-Tach®
480 l	420 kg	767 mm	1880 mm	786 mm	N51502082

Verplichte uitrusting van machines : 



**4-in-1 bak (compacte machines) - B4x1 2140 / 560 (a)**

Capaciteit van de koepel	Gewicht	Totale hoogte	Breedte	Diepte	All-Tach®
560 l	475 kg	767 mm	2140 mm	786 mm	N700255

Verplichte uitrusting van machines : 

BAKKEN

**4-in-1 bak met tanden(compacte machines)**



**4-in-1 bak met tanden(compacte machines) - B4x1 1830 / 450 T (a)**

Capaciteit van de koepel	Gewicht	Totale hoogte	Breedte	Diepte	All-Tach®
450 l	420 kg	767 mm	1830 mm	800 mm	N757025

Verplichte uitrusting van machines : 

**4-in-1 bak met tanden(compacte machines) - B4x1 1880 / 480 T**

Capaciteit van de koepel	Gewicht	Totale hoogte	Breedte	Diepte	All-Tach®
480 l	420 kg	767 mm	1880 mm	786 mm	N51502083

Verplichte uitrusting van machines :

**4-in-1 bak met tanden(compacte machines) - B4x1 2140 / 560 T (a)**

Capaciteit van de koepel	Gewicht	Totale hoogte	Breedte	Diepte	All-Tach®
560 l	475 kg	767 mm	2140 mm	786 mm	N700256

Verplichte uitrusting van machines :

## BAKKEN

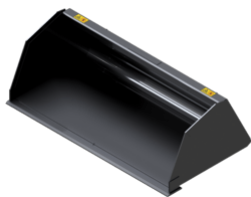
**Allroundbak (compacte machines)**

**Allroundbak (compacte machines) - BU 1880 / 900**

Capaciteit	Capaciteit van de koepel	Gewicht	Totale hoogte	Breedte	Diepte
1350 kg	900 l	360 kg	732 mm	1880 mm	1055 mm
All-Tach®					
N51502074					

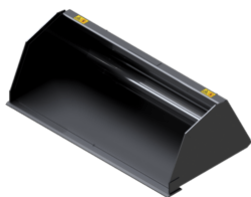
Verplichte uitrusting van machines :

**Allroundbak (compacte machines) - BU 2080 / 1010**

Capaciteit	Capaciteit van de koepel	Gewicht	Totale hoogte	Breedte	Diepte
1515 kg	1010 l	370 kg	732 mm	2080 mm	1055 mm
All-Tach®					
N51502075					

Verplichte uitrusting van machines :

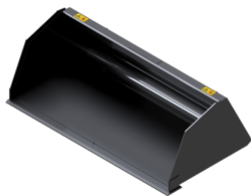
**Allroundbak (compact machines) - BU 2140 / 1050 (a)**

Capaciteit	Capaciteit van de koepel	Gewicht	Totale hoogte	Breedte	Diepte
1575 kg	1050 l	378 kg	732 mm	2140 mm	1055 mm
<b>All-Tach®</b>					
N700247					

Verplichte uitrusting van machines : ✕

## BAKKEN

**Groot volumebak (compact machines)**

**Groot volumebak (compact machines) - BLM 2080 / 1250**

Capaciteit	Capaciteit van de koepel	Gewicht	Totale hoogte	Breedte	Diepte
1250 kg	1250 l	370 kg	832 mm	2080 mm	1102 mm
<b>All-Tach®</b>					
N51502076					

Verplichte uitrusting van machines : ✕

**Groot volumebak (compact machines) - BLM 2140 / 1290**

Capaciteit	Capaciteit van de koepel	Gewicht	Totale hoogte	Breedte	Diepte
1290 kg	1290 l	381 kg	832 mm	2140 mm	1102 mm
<b>All-Tach®</b>					
N700248					

Verplichte uitrusting van machines : ✕

## BAKKEN

**Industriële klem (compact machines)**

**Industriële klem (compact machines) - BGI 2080 / 700**

Capaciteit van de koepel	Gewicht	Breedte	Gesloten grijphoogte	Diepte	All-Tach®
700 l	475 kg	2080 mm	761 mm	1007 mm	N51502084

Verplichte uitrusting van machines : ☐☐

## BAKKEN

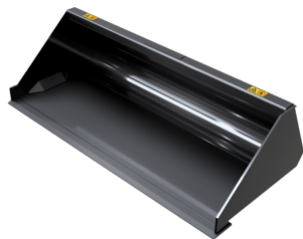
**Sloopbak met hoge weerstand (Compacte machines)****Sloopbak met hoge weerstand (Compacte machines) - BD 1880 / 750**

Capaciteit van de koepel	Gewicht	Totale hoogte	Breedte	Diepte	All-Tach®
750 l	315 kg	600 mm	1880 mm	1100 mm	N51502073

Verplichte uitrusting van machines : ✕

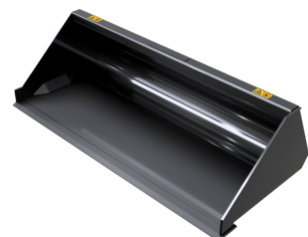
**Sloopbak met hoge weerstand (Compacte machines) - BD 2140 / 870 (a)**

Capaciteit van de koepel	Gewicht	Totale hoogte	Breedte	Diepte	All-Tach®
870 l	320 kg	600 mm	2140 mm	1100 mm	N700246

Verplichte uitrusting van machines : ✕

## BAKKEN

**Standaard graafbak (compacte machines)****Standaard graafbak (compacte machines) - BS 1880 / 750**

Capaciteit van de koepel	Gewicht	Totale hoogte	Breedte	Diepte	All-Tach®
750 l	315 kg	600 mm	1880 mm	1100 mm	N51502071

Verplichte uitrusting van machines : ✕

**Standaard graafbak (compacte machines) - BS 2140 / 870 (a)**

Capaciteit van de koepel	Gewicht	Totale hoogte	Breedte	Diepte	All-Tach®
870 l	320 kg	600 mm	2140 mm	1100 mm	N700244

Verplichte uitrusting van machines : ✕

## BAKKEN

## Standaard graafbak met tanden (compacte machines)

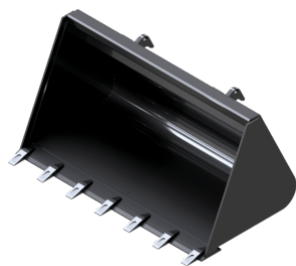

## Standaard graafbak met tanden (compacte machines) - BS 1880 / 750 T

Capaciteit van de koepel	Gewicht	Totale hoogte	Breedte	Diepte	All-Tach®
750 l	315 kg	600 mm	1880 mm	1100 mm	N51502072

Verplichte uitrusting van machines : ✕

## Standaard graafbak met tanden (compacte machines) - BS 2140 / 870 T (a)

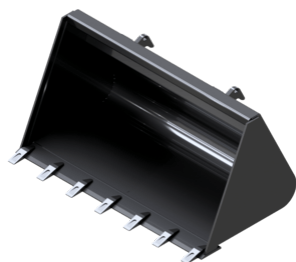

Capaciteit van de koepel	Gewicht	Totale hoogte	Breedte	Diepte	All-Tach®
870 l	320 kg	600 mm	2140 mm	1100 mm	N700245

Verplichte uitrusting van machines : ✕

## VORKDRAGERS

## Palletvorken compleet (compacte machines)



## Palletvorken compleet (compacte machines) - CAT 1220 / 1100 (a)

Capaciteit	Totale hoogte	Lengte vorken	Breedte	Diepte
1100 kg	890 mm	1100 mm	1212 mm	1318 mm

Verplichte uitrusting van machines : ✕

## Palletvorken compleet (compacte machines) - CAT 1220 / 1200 (a)



Capaciteit	Totale hoogte	Lengte vorken	Breedte	Diepte
1200 kg	890 mm	1200 mm	1212 mm	1318 mm

Verplichte uitrusting van machines : ✕



## VORKEN EN GRIJPERS

**Mestvork (compacte machines)****Mestvork (compacte machines) - FM 1850 (a)**

Gewicht	Totale hoogte	Breedte	Diepte	All-Tach®
153 kg	600 mm	1850 mm	870 mm	N757031

Verplichte uitrusting van machines : ✕

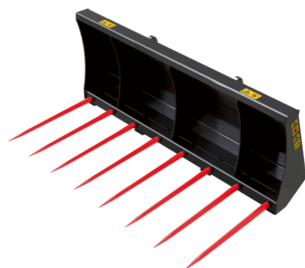
**Mestvork (compacte machines) - FM 1850 (b)**

Gewicht	Totale hoogte	Breedte	Diepte	All-Tach®
153 kg	600 mm	1850 mm	870 mm	N51502480

Verplichte uitrusting van machines : ✕

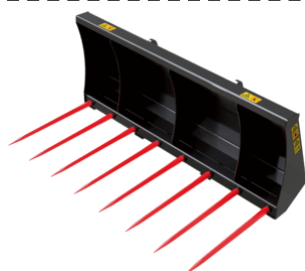
**Mestvork (compacte machines) - FM 1880**

Gewicht	Totale hoogte	Breedte	Diepte	All-Tach®
153 kg	600 mm	1880 mm	870 mm	N51502080

Verplichte uitrusting van machines : ✕

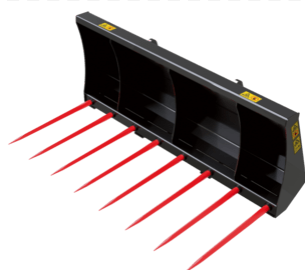
**Mestvork (compacte machines) - FM 2140**

Gewicht	Totale hoogte	Breedte	Diepte	All-Tach®
170 kg	600 mm	2140 mm	870 mm	N700260

Verplichte uitrusting van machines : ✕

## VORKEN EN GRIJPERS

**Mestvork met klem (compacte machines)****Mestvork met klem (compacte machines) - FMG 1850 / 660 (a)**

Capaciteit van de koepel	Gewicht	Totale hoogte	Breedte	Diepte	All-Tach®
660 l	280 kg	796 mm	1850 mm	1028 mm	N757033

Verplichte uitrusting van machines :

**Mestvork met klem (compacte machines) - FMG 1880 / 660**

Capaciteit van de koepel	Gewicht	Totale hoogte	Breedte	Diepte	All-Tach®
660 l	280 kg	796 mm	1880 mm	1028 mm	N51502081

Verplichte uitrusting van machines :

**Mestvork met klem (compacte machines) - FMG 2140 / 760 (a)**

Capaciteit van de koepel	Gewicht	Totale hoogte	Breedte	Diepte	All-Tach®
760 l	310 kg	796 mm	2140 mm	1028 mm	N700261

Verplichte uitrusting van machines :

## VEEGMACHINES

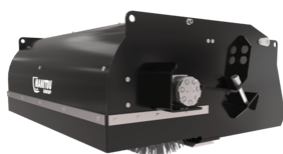
**Veegbak (compacte machines)****Veegbak (compacte machines) - SCB 1850 (a)**

Gewicht	Totale hoogte	Breedte	Diepte	All-Tach®
460 kg	690 mm	2100 mm	1313 mm	N757045

Verplichte uitrusting van machines :



**Veegbak (compacte machines) - SCB 2080**

Gewicht	Totale hoogte	Breedte	Diepte	All-Tach®
525 kg	690 mm	2330 mm	1308 mm	N700266

Verplichte uitrusting van machines :

EARTH DRILLING AND DIGGING SOLUTIONS

**Hydraulische hamer (Compacte machines)**



**Hydraulische hamer (Compacte machines) - H 240**

Gewicht	Totale hoogte	Diameter minimum	All-Tach®
236 kg	1016 mm	67.50 mm	N51502211

Verplichte uitrusting van machines :



**Hydraulische hamer (Compacte machines) - H 330**

Gewicht	Totale hoogte	Diameter minimum	All-Tach®
330 kg	1112 mm	77.50 mm	N51502212

Verplichte uitrusting van machines :

SNOW REMOVING SOLUTIONS

**Sneeuwblazer (compacte machines)**



**Sneeuwblazer (compacte machines) - SBL 2100**

Gewicht	Totale hoogte	Breedte	Diameter 1	Diameter 2	All-Tach®
540 kg	2100 mm	2100 mm	450 mm	420 mm	N51502229

Verplichte uitrusting van machines : + +

## SNOW REMOVING SOLUTIONS

**Sneeuwschuiver (compacte machines)****Sneeuwschuiver (compacte machines) - BLS 2400 / 900 (a)**

Gewicht	Totale hoogte	Breedte	Diepte	All-Tach®
410 kg	800 mm	2400 mm	900 mm	N51502227

Verplichte uitrusting van machines :  + 

## LEVELLING SOLUTIONS

**Hydr. Dozer blad (compacte machines)****Hydr. Dozer blad (compacte machines) - BLD 2135 H**

Gewicht	Totale hoogte	Breedte	Diepte	All-Tach®
470 kg	677 mm	2135 mm	813 mm	N51502085

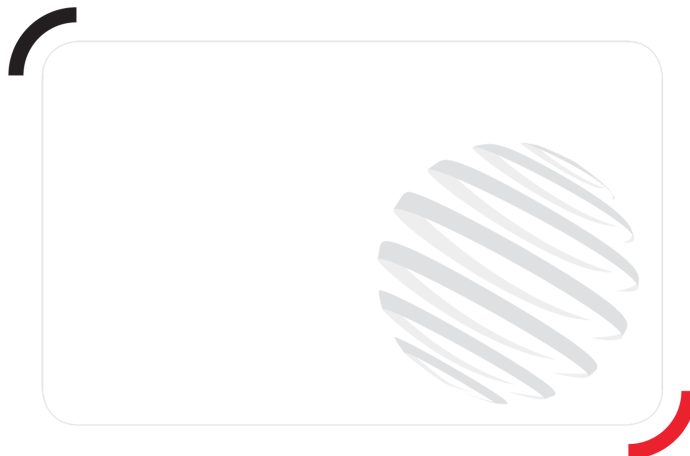

**Hoofdkantoor**

B.P. 249 - 430 rue de l'Aubinière

44150 Ancenis Cedex - Frankrijk

Tel.: 00 33 (0)2 40 09 10 11 - Fax: 00 33 (0)2 40 09 10 97

[www.manitou.com](http://www.manitou.com)



Deze brochure beschrijft versies en configuratie-opties voor Manitou-producten die met verschillende apparatuur kunnen worden uitgerust. De uitrusting die in deze brochure wordt beschreven, kan standaard, optioneel of niet leverbaar zijn, afhankelijk van de uitvoering. Manitou behoudt zich het recht voor om de weergegeven en beschreven specificaties op elk moment en zonder kennisgeving vooraf te wijzigen. De fabrikant is niet aansprakelijk voor de gegeven specificaties. Neem voor meer informatie contact op met uw Manitou-dealer. Niet-contractueel document. De productbeschrijvingen kunnen afwijken van de werkelijke producten. De lijst met specificaties is niet allesomvattend. De logo's en visuele identiteit van het bedrijf zijn eigendom van Manitou en mogen niet zonder toestemming worden gebruikt. Alle rechten voorbehouden. De foto's en diagrammen in deze brochure zijn uitsluitend bedoeld voor raadpleging en informatie.  
MANITOU BF SA - Naamloze vennootschap met raad van bestuur - Aandeelkapitaal: 39.668.399 euro - 857 802 508 RCS Nantes