

Nederlands

Knikladers

MLA/MLA-T

MLA 4-50 H

MACHINEBOOK



Hoedanigheid		Metrisch
Statische kieplading met bak (recht)		1540 kg
Statische kieplading met bak (volledige omwenteling)		1355 kg
Statische kieplading met vorken (recht)		1175 kg
Statische kieplading met vorken (volledige omwenteling)		1030 kg
Max. hoogte van het draaipunt van de arm	h35	2836 mm
Gewicht en afmetingen		
Onbelast gewicht (met vorken) met overkapping met 4 palen		2316 kg
Wielbasis (y)	y	1650 mm
Totale breedte cabine	b4	991 mm
Totale hoogte met overkapping met 4 palen	h38	2258 mm
Dump reach - Full height	r6	479 mm
Kap hoogte	h40	1405 mm
Overall Operating Height - Fully Raised	h27	3636 mm
Schamierhoek	a19	45 °
Maximum oscillation angle		11 °
Overall length with bucket	l16	4279 mm
Overall width less bucket	b1	1100 mm
Overall length - Less Bucket	l2	3583 mm
Overhanging achteraan	c6	1120 mm
Dump angle - Fully raised	a5	42 °
Dump Height - Fully Raised	h29	2126 mm
Maximum Rollback Angle - Fully Raised	a4	48 °
Digging Position	h32	-79 mm
Bodemvrijheid machine	m4	320 mm
Clearance Radius - Front with Bucket	b18	3246 mm
Clearance Radius - Less bucket	b14	2767 mm
Grondvlak tot hoogte rand van de bak	h42	2655 mm
Tread width (wheel center)	b29	836 mm
Vrije ruimte bij draaien hulpstuk		103 mm
Height from ground to axle center	m8	214 mm
Bakbreedte	e1	1520 mm
Midden voorwiel tot spilpen	m3	669 mm
Hoogte tot schamierpen - volledig verhoogd	h28	2900 mm
Motor		
Merk		Perkins
Motormodel		403J-E17T
Motomorm		Stage V
Aantal cilinders		3
I.C. Motorvermogen / Vermogen		48 Hp / 36 kW
Max. koppel / Motorkoppel		166 Nm / 1600 rpm
Motorkoelingsysteem		Water
Transmissie		
Type		Hydrostatisch
Aantal versnellingen (vooruit / achteruit)		2 / 2
Max. verplaatsingssnelheid (kan variëren volgens de toepasselijke reglementering)		20 km/h
Max. travel speed (in option) (may vary according to applicable regulations)		30 km/h
Bedrijfsrem		Hydraulic drum brake on front axle, acting on all 4 wheels
Hydraulisch		
Pomptype		Tandwielpomp
Hydraulisch debiet - Hydraulische druk		60 l/min / 207 bar
Hoog debietoptie (l/min)		60 l/min
Tankinhoud		
Hydraulische olie		48 l
Inhoud brandstoftank		45 l

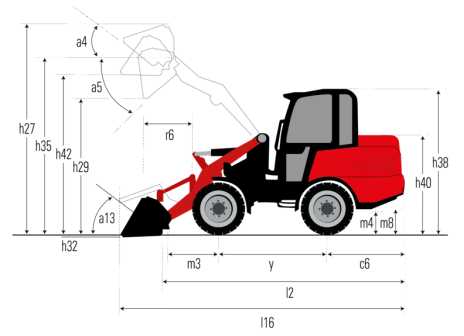
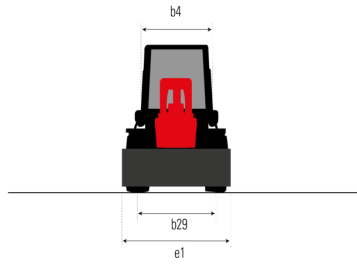
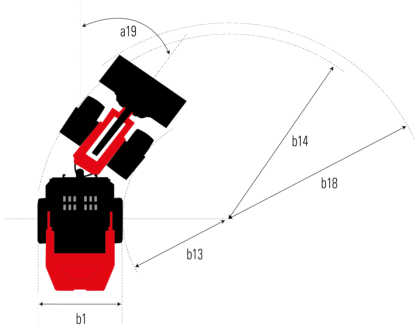

BAKKEN

4-in-1 bak (compacte machines)



4-in-1 bak (compacte machines) - B4x1 1080 / 170

Capaciteit van de koepel	Gewicht	Totale hoogte	Breedte	Diepte	All-Tach® Narrow
170 l	180 kg	713 mm	1080 mm	770 mm	N51502388

Verplichte uitrusting van machines : 



4-in-1 bak (compacte machines) - B4x1 1380 / 270

Capaciteit van de koepel	Gewicht	Totale hoogte	Breedte	Diepte	All-Tach® Narrow
270 l	212 kg	713 mm	1380 mm	770 mm	N004046
4 point Carriage	Euro Carriage				
N51502391	N51502134				

Verplichte uitrusting van machines : 

BAKKEN

4-in-1 bak met tanden(compacte machines)



4-in-1 bak met tanden(compacte machines) - B4x1 1380 / 270 T

Capaciteit van de koepel	Gewicht	Totale hoogte	Breedte	Diepte	All-Tach® Narrow
270 l	219 kg	713 mm	1380 mm	870 mm	N004070
4 point Carriage	Euro Carriage				
N51502394	N51502137				

Verplichte uitrusting van machines : 

BAKKEN

Groot volumebak (compacte machines)



Groot volumebak (compacte machines) - BLM 1080 / 510

Capaciteit	Capaciteit van de koepel	Gewicht	Totale hoogte	Breedte	Diepte
510 kg	510 l	173 kg	775 mm	1080 mm	1025 mm
All-Tach® Narrow	4 point Carriage	Euro Carriage			
N004022	N003022	N51502113			

Verplichte uitrusting van machines : 



Groot volumebak (compacte machines) - BLM 1200 / 580

Capaciteit	Capaciteit van de koepel	Gewicht	Totale hoogte	Breedte	Diepte
580 kg	580 l	184 kg	775 mm	1200 mm	1025 mm
All-Tach® Narrow	4 point Carriage	Euro Carriage			
N004023	N003023	N51502114			

Verplichte uitrusting van machines : ✕



Groot volumebak (compacte machines) - BLM 1300 / 630 (a)

Capaciteit	Capaciteit van de koepel	Gewicht	Totale hoogte	Breedte	Diepte
630 kg	630 l	196 kg	775 mm	1300 mm	1025 mm
All-Tach® Narrow	4 point Carriage	Euro Carriage			
N004024	N003024	N51502115			

Verplichte uitrusting van machines : ✕



Groot volumebak (compacte machines) - BLM 1300 / 630 (b)

Capaciteit	Capaciteit van de koepel	Gewicht	Totale hoogte	Breedte	Diepte
630 kg	630 l	203 kg	775 mm	1300 mm	988 mm
All-Tach®	4 point Carriage	Euro Carriage			
N004088	N003088	N51502160			

Verplichte uitrusting van machines : ✕



Groot volumebak (compacte machines) - BLM 1400 / 680 (a)

Capaciteit	Capaciteit van de koepel	Gewicht	Totale hoogte	Breedte	Diepte
680 kg	680 l	194 kg	775 mm	1400 mm	1025 mm
All-Tach® Narrow	4 point Carriage	Euro Carriage			
N004025	N003025	N002025			

Verplichte uitrusting van machines : ✕



Groot volumebak (compacte machines) - BLM 1400 / 680 (b)

Capaciteit	Capaciteit van de koepel	Gewicht	Totale hoogte	Breedte	Diepte
680 kg	680 l	210 kg	775 mm	1400 mm	988 mm
All-Tach®	4 point Carriage	Euro Carriage			
N004089	52799520	N51502161			

Verplichte uitrusting van machines : ✕

BAKKEN

Pelikaanbak (compacte machines)



Pelikaanbak (compacte machines) - BG 1200 / 430

Capaciteit van de koepel	Gewicht	Breedte	Gesloten grijphoogte	Diepte	All-Tach® Narrow
430 l	268 kg	1200 mm	840 mm	995 mm	N51502263
4 point Carriage	Euro Carriage				
52799522	N51502286				

Verplichte uitrusting van machines :



Pelikaanbak (compacte machines) - BG 1300 / 470

Capaciteit van de koepel	Gewicht	Totale hoogte	Breedte	Diepte	All-Tach® Narrow
470 l	270 kg	840 mm	1300 mm	995 mm	N51502216
4 point Carriage	Euro Carriage				
N51502275	N51502287				

Verplichte uitrusting van machines :



Pelikaanbak (compacte machines) - BG 1400 / 510 (a)

Capaciteit van de koepel	Gewicht	Totale hoogte	Breedte	Diepte	All-Tach® Narrow
510 l	275 kg	840 mm	1400 mm	995 mm	N51502264
4 point Carriage	Euro Carriage				
N51502276	N51502288				

Verplichte uitrusting van machines :

BAKKEN

Standaard graafbak (compacte machines)



Standaard graafbak (compacte machines) - BS 1080 / 300

Capaciteit van de koepel	Gewicht	Totale hoogte	Breedte	Diepte	All-Tach® Narrow
300 l	126 kg	626 mm	1080 mm	817 mm	N004012
4 point Carriage	Euro Carriage				
N003012	N51502101				

Verplichte uitrusting van machines : ✕



Standaard graafbak (compacte machines) - BS 1150 / 320

Capaciteit van de koepel	Gewicht	Totale hoogte	Breedte	Diepte	All-Tach® Narrow
320 l	135 kg	626 mm	1150 mm	817 mm	N004013
4 point Carriage	Euro Carriage				
N003013	N51502102				

Verplichte uitrusting van machines : ✕



Standaard graafbak (compacte machines) - BS 1200 / 340

Capaciteit van de koepel	Gewicht	Totale hoogte	Breedte	Diepte	All-Tach® Narrow
340 l	136 kg	626 mm	1200 mm	817 mm	N004014
4 point Carriage	Euro Carriage				
N003014	N51502103				

Verplichte uitrusting van machines : ✕



Standaard graafbak (compacte machines) - BS 1300 / 370

Capaciteit van de koepel	Gewicht	Totale hoogte	Breedte	Diepte	All-Tach® Narrow
340 l	145 kg	626 mm	1300 mm	817 mm	N004015
4 point Carriage	Euro Carriage				
N003015	N002015				

Verplichte uitrusting van machines : ✕



Standaard graafbak (compacte machines) - BS 1400 / 400

Capaciteit van de koepel	Gewicht	Totale hoogte	Breedte	Diepte	All-Tach® Narrow
400 l	151 kg	626 mm	1400 mm	817 mm	N004016
4 point Carriage N003016	Euro Carriage N002016				

Verplichte uitrusting van machines : ✕



Standaard graafbak (compacte machines) - BS 1400 / 410

Capaciteit van de koepel	Gewicht	Totale hoogte	Breedte	Diepte	All-Tach®
410 l	180 kg	675 mm	1400 mm	760 mm	N004077
4 point Carriage 52807869	Euro Carriage N51502155				

Verplichte uitrusting van machines : ✕

BAKKEN

Standaard graafbak met tanden (compacte machines)

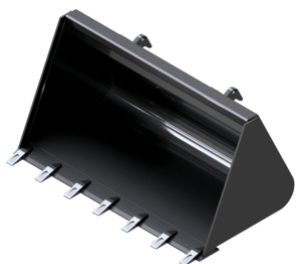

Standaard graafbak met tanden (compacte machines) - BS 1080 / 300 T

Capaciteit van de koepel	Gewicht	Totale hoogte	Breedte	Diepte	All-Tach® Narrow
300 l	132 kg	626 mm	1080 mm	907 mm	N004054
4 point Carriage N003054	Euro Carriage N51502107				

Verplichte uitrusting van machines : ✕

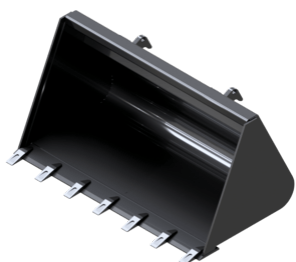

Standaard graafbak met tanden (compacte machines) - BS 1150 / 320 T

Capaciteit van de koepel	Gewicht	Totale hoogte	Breedte	Diepte	All-Tach® Narrow
320 l	142 kg	626 mm	1150 mm	898 mm	N004055
4 point Carriage N003055	Euro Carriage N51502108				

Verplichte uitrusting van machines : ✕

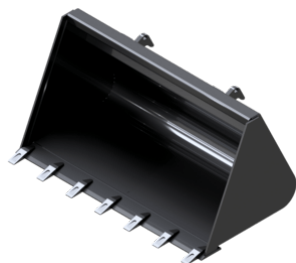

Standaard graafbak met tanden (compacte machines) - BS 1200 / 340 T

Capaciteit van de koepel	Gewicht	Totale hoogte	Breedte	Diepte	All-Tach® Narrow
340 l	142 kg	626 mm	1200 mm	907 mm	N004056
4 point Carriage	Euro Carriage				
N003056	N51502109				

Verplichte uitrusting van machines : ✕

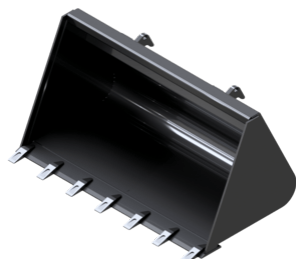

Standaard graafbak met tanden (compacte machines) - BS 1300 / 370 T

Capaciteit van de koepel	Gewicht	Totale hoogte	Breedte	Diepte	All-Tach® Narrow
370 l	151 kg	626 mm	1300 mm	907 mm	N004057
4 point Carriage	Euro Carriage				
N003057	N51502110				

Verplichte uitrusting van machines : ✕

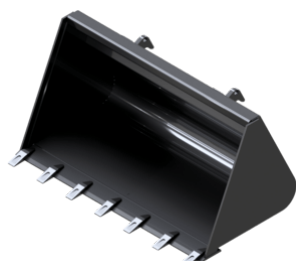

Standaard graafbak met tanden (compacte machines) - BS 1400 / 400 T

Capaciteit van de koepel	Gewicht	Totale hoogte	Breedte	Diepte	All-Tach® Narrow
400 l	158 kg	626 mm	1400 mm	907 mm	N004058
4 point Carriage	Euro Carriage				
N003058	N51502111				

Verplichte uitrusting van machines : ✕

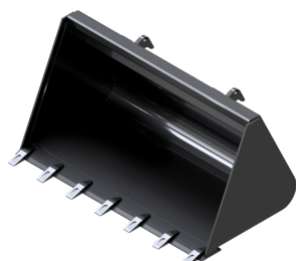

Standaard graafbak met tanden (compacte machines) - BS 1400 / 410 T

Capaciteit van de koepel	Gewicht	Totale hoogte	Breedte	Diepte	All-Tach®
410 l	187 kg	675 mm	1400 mm	822 mm	N004083
4 point Carriage	Euro Carriage				
52799519	N51502158				

Verplichte uitrusting van machines : ✕

KLEMMEN

Gewikkelde balenklem (compacte machines)



Gewikkelde balenklem (compacte machines) - CLBW 800

Afstand tot zwaartepunt	Capaciteit	Gewicht	Totale hoogte	Totale lengte	Breedte
441 mm	800 kg	227 kg	810 mm	1310 mm	1587 mm
Diameter minimum / Diameter maximum	All-Tach® Narrow	All-Tach®	4 point Carriage	Euro Carriage	
820 mm / 1504 mm	N51502697	N51502013	N51502429	N51502430	

Verplichte uitrusting van machines :

KLEMMEN

Pottenklem (compacte machines)

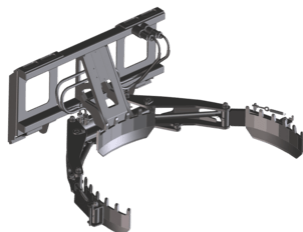

Pottenklem (compacte machines) - CLP 1000 / 800

Afstand tot zwaartepunt	Capaciteit	Gewicht	Totale hoogte	Totale lengte	Breedte
350 mm	800 kg	109 kg	507 mm	1106 mm	686 mm
Diameter minimum / Diameter maximum	All-Tach® Narrow	All-Tach®	4 point Carriage	Euro Carriage	
400 mm / 1050 mm	N51502717	N51502716	52742066	52742067	

Verplichte uitrusting van machines :

KLEMMEN

Ronde balenklem (compacte machines)



Ronde balenklem (compacte machines) - CLBR 2x2 / 800

Afstand tot zwaartepunt	Capaciteit	Gewicht	Totale hoogte	Totale lengte	Breedte
341 mm	800 kg	150 kg	869 mm	910 mm	1090 mm
All-Tach® Narrow	All-Tach®	4 point Carriage	Euro Carriage		
N51502696	N51502631	N51502632	N51502633		

Verplichte uitrusting van machines :

VORKDRAGERS

Palletvorken compleet (compacte machines)



Palletvorken compleet (compacte machines) - CAT 920 / 1000

Capaciteit	Totale hoogte	Lengte vorken	Breedte	Diepte	All-Tach® Narrow
1000 kg	893 mm	1000 mm	915 mm	1160 mm	52807868
All-Tach®	4 point Carriage	Euro Carriage			
N004019	52813313	52807866			

Verplichte uitrusting van machines :



Palletvorken compleet (compacte machines) - CAT 920 / 1100

Capaciteit	Totale hoogte	Lengte vorken	Breedte	Diepte	All-Tach® Narrow
1100 kg	893 mm	1100 mm	915 mm	1260 mm	52807867
4 point Carriage	Euro Carriage				
52796388	52799511				

Verplichte uitrusting van machines : ✕



Palletvorken compleet (compacte machines) - CAT 920 / 1200

Capaciteit	Totale hoogte	Lengte vorken	Breedte	Diepte	All-Tach® Narrow
1200 kg	893 mm	1200 mm	915 mm	1360 mm	52799512
4 point Carriage					
52799521					

Verplichte uitrusting van machines : ✕



Palletvorken compleet (compacte machines) - CAT 1210 / 1200 (b)

Capaciteit	Totale hoogte	Lengte vorken	Breedte	Diepte	All-Tach®
1200 kg	890 mm	1200 mm	1212 mm	1350 mm	52799516
4 point Carriage	Euro Carriage				
52799513	52799514				

Verplichte uitrusting van machines : ✕

VORKDRAGERS

Rijtuig Drijvende Laadsteun En Vorken (MT - MLT)



Rijtuig Drijvende Laadsteun En Vorken (MT - MLT) - CAF 1000 / 1.5 LB

Afstand tot zwaartepunt	Capaciteit	Gewicht	Totale hoogte	Totale lengte	Breedte
168 mm	1500 kg	175 kg	1049 mm	1384 mm	1156 mm
All-Tach®	4 point Carriage	Euro Carriage			
52693600	52723634	52723635			

Verplichte uitrusting van machines : ✕

VORKEN EN GRIJPERS

Balenvork (compacte machines)



Balenvork (compacte machines) - FB 950 / 700

Capaciteit	Gewicht	Totale hoogte	Totale lengte	Lengte vorken	Breedte
700 kg	73 kg	610 mm	850 mm	670 mm	1150 mm
Diepte	All-Tach® Narrow	All-Tach®	4 point Carriage	Euro Carriage	
820 mm	N51502699	N51502684	N51502685	N51502686	

Verplichte uitrusting van machines : ✕



Balenvork (compacte machines) - FB 950 / 700 LB

Afstand tot zwaartepunt	Capaciteit	Gewicht	Totale hoogte	Totale lengte	Lengte vorken
155 mm	700 kg	72 kg	1061 mm	1230 mm	950 mm
Breedte	Diepte	All-Tach® Narrow	All-Tach®	4 point Carriage	Euro Carriage
1127 mm	1230 mm	N51502698	N51502687	N51502688	N51502689

Verplichte uitrusting van machines : ✕

VORKEN EN GRIJPERS

Mestvork (compacte machines)



Mestvork (compacte machines) - FM 1200 (a)

Gewicht	Totale hoogte	Breedte	Diepte	All-Tach® Narrow	4 point Carriage
109 kg	694 mm	1200 mm	843 mm	52799526	52799531
Euro Carriage	52807871				

Verplichte uitrusting van machines : ✕

VORKEN EN GRIJPERS

Mestvork met klem (compacte machines)



Mestvork met klem (compacte machines) - FMG 1100 / 320

Capaciteit van de koepel	Gewicht	Totale hoogte	Breedte	Diepte	Euro Carriage
290 l	145 kg	746 mm	1100 mm	848 mm	52807870

Verplichte uitrusting van machines : ☐☐



Mestvork met klem (compact machines) - FMG 1200 / 320 (a)

Capaciteit van de koepel	Gewicht	Totale hoogte	Breedte	Diepte	All-Tach® Narrow
320 l	144 kg	746 mm	1200 mm	904 mm	52799524
4 point Carriage	Euro Carriage				
52796387	52799523				

Verplichte uitrusting van machines :

GIEKEN

Op frame gemonteerd haak



Op frame gemonteerd haak - JH 2500

Afstand tot zwaartepunt	Capaciteit	Gewicht	Max. bereik	Totale hoogte	Totale lengte
229 mm	2500 kg	85 kg	506 mm	605 mm	654 mm
Breedte	All-Tach®	4 point Carriage	Euro Carriage		
696 mm	52579090	52742070	52742071		

Verplichte uitrusting van machines :

VEEGMACHINES

Orienteerbare borstel (compacte machines)

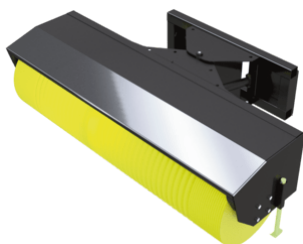

Orienteerbare borstel (compacte machines) - SCA 1330

Gewicht	Totale hoogte	Breedte	Diepte	All-Tach® Narrow	4 point Carriage
360 kg	684 mm	1448 mm	1331 mm	N004039	N51502376
Euro Carriage					
N51502380					

Verplichte uitrusting van machines :



Orienteerbare borstel (compacte machines) - SCA 1530

Gewicht	Totale hoogte	Breedte	Diepte	All-Tach® Narrow	All-Tach®
400 kg	684 mm	1753 mm	1331 mm	N004040	N004041
4 point Carriage	Euro Carriage				
N51502377	N51502381				

Verplichte uitrusting van machines :

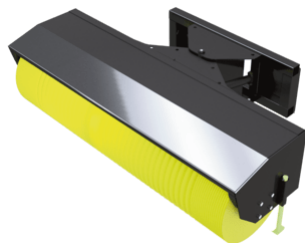

Orienteerbare borstel (compacte machines) - SCA 1680

Gewicht	Totale hoogte	Breedte	Diepte	All-Tach®	4 point Carriage
410 kg	684 mm	1908 mm	1331 mm	N004042	N51502378
Euro Carriage					
N51502382					

Verplichte uitrusting van machines : 

VEEGMACHINES

Veegbak (compacte machines)



Veegbak (compacte machines) - SCB 1380

Gewicht	Totale hoogte	Breedte	Diepte	All-Tach® Narrow
310 kg	652 mm	1631 mm	1222 mm	N004037

Verplichte uitrusting van machines : 

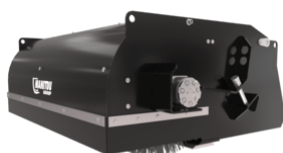

Veegbak (compacte machines) - SCB 1525 (a)

Gewicht	Totale hoogte	Breedte	Diepte	All-Tach®
346 kg	652 mm	1776 mm	1222 mm	N004038

Verplichte uitrusting van machines : 

SNOW REMOVING SOLUTIONS

Sneeuwschuiver (compacte machines)



Sneeuwschuiver (compacte machines) - BLS 1500

Gewicht	Totale hoogte	Breedte	Diepte	All-Tach® Narrow	4 point Carriage
220 kg	700 mm	1500 mm	900 mm	N51502219	N51502217
Euro Carriage					
N51502218					

Verplichte uitrusting van machines :  + 



Sneeuwschuiver (compacte machines) - BLS 1800

Gewicht	Totale hoogte	Breedte	Diepte	All-Tach®	4 point Carriage
280 kg	700 mm	1800 mm	900 mm	N51502224	N51502222
Euro Carriage					
N51502223					

Verplichte uitrusting van machines :  + 

LEVELLING SOLUTIONS

Dozer blad (compacte machines)



Dozer blad (compacte machines) - BLD 1525

Gewicht	Totale hoogte	Breedte	Diepte	All-Tach®	4 point Carriage
240 kg	677 mm	1525 mm	813 mm	N700396	N750996
Euro Carriage					
N51502207					

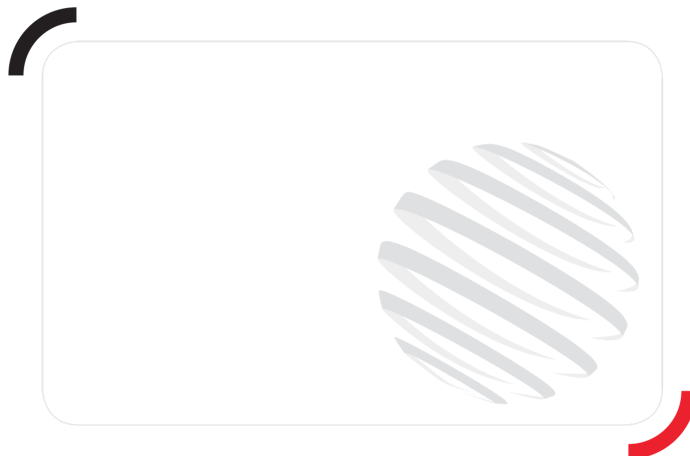

Hoofdkantoor

B.P. 249 - 430 rue de l'Aubinière

44150 Ancenis Cedex - Frankrijk

Tel.: 00 33 (0)2 40 09 10 11 - Fax: 00 33 (0)2 40 09 10 97

www.manitou.com



Deze brochure beschrijft versies en configuratie-opties voor Manitou-producten die met verschillende apparatuur kunnen worden uitgerust. De uitrusting die in deze brochure wordt beschreven, kan standaard, optioneel of niet leverbaar zijn, afhankelijk van de uitvoering. Manitou behoudt zich het recht voor om de weergegeven en beschreven specificaties op elk moment en zonder kennisgeving vooraf te wijzigen. De fabrikant is niet aansprakelijk voor de gegeven specificaties. Neem voor meer informatie contact op met uw Manitou-dealer. Niet-contractueel document. De productbeschrijvingen kunnen afwijken van de werkelijke producten. De lijst met specificaties is niet allesomvattend. De logo's en visuele identiteit van het bedrijf zijn eigendom van Manitou en mogen niet zonder toestemming worden gebruikt. Alle rechten voorbehouden. De foto's en diagrammen in deze brochure zijn uitsluitend bedoeld voor raadpleging en informatie.
MANITOU BF SA - Naamloze vennootschap met raad van bestuur - Aandeelkapitaal: 39.668.399 euro - 857 802 508 RCS Nantes